



2021 Product & Service Catalog



Safety Commitment

At Industrial Services Solutions, we start every action and day with a commitment and focus on safety. Our commitment to safety allows our employees and partners to deliver the best in class equipment, parts, and service for our customers in a safe work environment.

This products catalog shows capabilities from our manufacturing and repair facilities, as well as our expert field operations, which we deliver safely and efficiently each and every day across the country. As one organization, we have adopted and combined the best practices found in our 45 locations to deliver safety at the center of everything that we do. We have taken our individual strengths to create an organization that delivers first class solutions for our customers.

Every action that we take as an organization is part of our commitment to providing a safe and healthy work environment for our employees, customers, vendors, and partners. The prevention of injuries is of such importance that we will not compromise our values and ethics in the interest of operations and productivity or any other business need – this results in a highly motivated and dedicated company in everything that we deliver.

Our approach to safety is to maximize the prevention of injuries by developing a culture of “No One Gets Hurt” and an understanding of the importance in a safe work environment. We believe that all accidents in the workplace are preventable, and our ultimate goal is to have no injuries in the workplace.

The key actions we take as a company are:

- + Foster a culture of “No One Gets Hurt” and promote a safety-first attitude in everything we do.
- + Comply with all relevant laws and regulations for safety, environmental and business dealings.
- + Follow the best industry practices in the exercise of our business.
- + Manage disposal of all wastes in a safe and environmentally responsible manner.
- + Commit to safety and train our employees on safe operations and processes.
- + If something goes wrong, we acknowledge and fix it.

Our commitment to safety starts at the top of the organization. We hold all members of management responsible and accountable for the safe working environment in our facilities and field locations. Our attitude and commitment has led to a successful safety culture focused on accident and incident prevention. Individual responsibility for doing work the right way – this approach is reflected in all actions that we take as an organization. This culture of safety first and doing all actions the right way has produced industry leading safety results and first-class quality products and service.

With Industrial Service Solutions, safety is not just a program – *safety is our culture.*



Wade Stockstill
CEO, Industrial Service Solutions

QUALITY POLICY STATEMENT

Industrial Service Solutions is committed to total customer satisfaction by supplying products of superior quality, manufactured to exacting specifications, and supported by a first-class technical and commercial service team. In order to achieve this commitment, we have numerous certifications and capabilities in our facilities across the country. We have facilities with ISO 9001:2015 certifications, UL/CSA certifications, Green Tag Repair Facilities and many others to meet any customer specification or requirement.

As part of our overall mission to maintain the highest quality standards in our products and services, Industrial Service Solutions focuses on the following quality objectives:

- + To reliably and consistently deliver products that exceed the quality requirements and expectations of our customers.
- + To develop, establish, and maintain a Quality Management System consistent with the requirements of ISO 9001:2015.
- + To seek and achieve continuous improvements in the quality and value of the products we provide.
- + To ensure that each employee takes responsibility and pride in implementing the quality system within their own work functions.

Safety and quality go hand in hand. We continually develop the entire Industrial Service Solutions team and are dedicated to upholding the spirit of our quality objectives and adhering to the directives required by our standards and practices. This results in the superior quality and service delivered by Industrial Service Solutions each and every day.

ONLINE VERSION

A live and up-to-date version of this catalog is available for online use and download at ISS-NA.com/Catalog. In the case of discrepancies between the print and electronic versions, we recommend to use the latest version (version located on back cover).



DISCLAIMER

The products and data sheets in this catalog reflect current Industrial Service Solutions standard production specifications. Industrial Service Solutions reserves the right to modify products and materials, including modifications undertaken to comply with specific customer requests and technical specifications without notice.

All manufacturers' names, numbers, symbols, and descriptions are used for reference purposes only and it is not implied that any motors, pumps, valves, or parts are a product of any of these manufacturers.

TABLE OF CONTENTS













5	Company Overview
20	Controls
30	Energy Storage
34	Motors
82	Pumps
102	Valves
116	Compressors
130	Pneumatics
136	Sawmills
144	Metal Recycling
152	Transit & Railroad
156	Water & Wastewater
166	Dimensions & Mounting



Company Overview

Industrial Service Solutions provides nationwide field, shop, and supply services for a diverse set of industrial markets with breadth and depth in application knowledge and equipment expertise. We are uniquely positioned to deliver a service level equivalent to an OEM, but quicker and more cost-effective. Our regional service and supply facilities combined with our nationwide field support, makes us the largest independent provider of industrial services in the United States, the most comprehensive single-source solution, and your best choice for long term support.

INDUSTRIES SERVED

- | | |
|---|--|
|  <i>Aircraft & Aerospace</i> |  <i>Downstream Oil & Gas</i> |
|  <i>Cement & Aggregates</i> |  <i>Midstream Oil & Gas</i> |
|  <i>Chemical & Petrochemical</i> |  <i>Upstream Oil & Gas</i> |
|  <i>Food & Beverage</i> |  <i>Pulp/Paper & Wood Products</i> |
|  <i>General Manufacturing</i> |  <i>PVC & Plastic</i> |
|  <i>Marine & Dredging</i> |  <i>Transit & Railroad</i> |
|  <i>Mining & Metals</i> |  <i>Tire & Rubber</i> |
|  <i>Power Generation</i> |  <i>Water & Wastewater</i> |

COMPANY AT A GLANCE

2500+
Employees

40+
Locations

3
Businesses

1
Company

Local Knowledge with National Experience

We aim to be your single source solution by coordinating the resources, processes, and technology to deliver nationwide repair, maintenance, installation, and major field and project services.

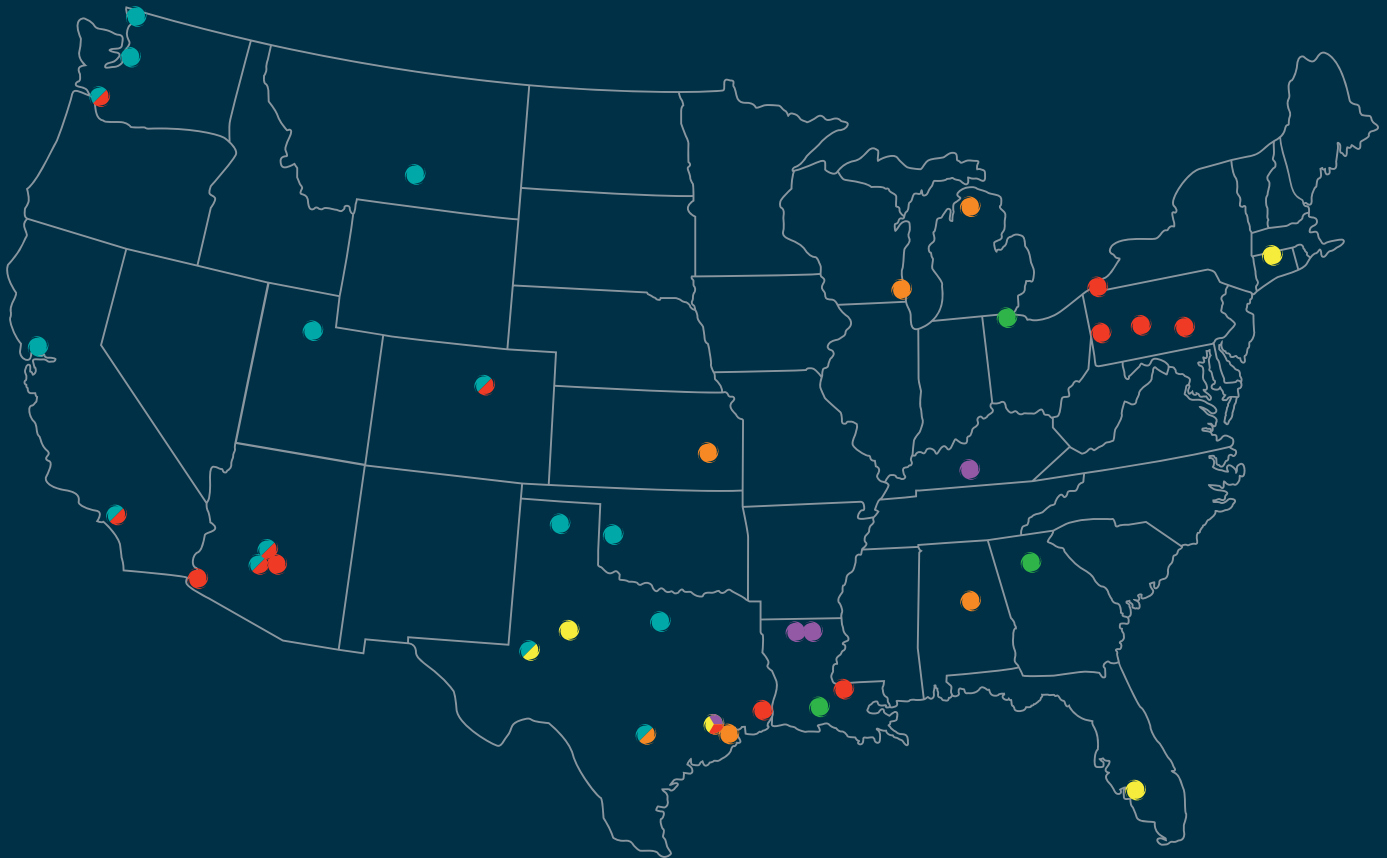

OUR EXPERTISE

- Valves & Actuation
- Mechanical & Construction
- Motors & Pumps
- Machining & Fabrication
- Boilers & Compressors
- Inspections

AL**MECHANICAL**

48150 US-280
Sylacauga, AL 35150
(888) 384-2067

AZ**MOTORS • PUMPS**

1106 S Center St
Mesa, AZ 85210
(888) 384-2113

VALVES • MOTORS • PUMPS

1822 E Jackson St
Phoenix, AZ 85034
(888) 384-2136 VALVES
(888) 384-2112 MOTORS/PUMPS

VALVES • PUMPS

4411 S 40th St, Ste D6
Phoenix, AZ 85040
(888) 384-2108

MOTORS • PUMPS

2130 E 16th St
Yuma, AZ 85364
(888) 384-2114

CA**VALVES**

3948 Teal Ct
Benicia, CA 94510
(888) 384-2085

VALVES • PUMPS

1916 S Lynx Pl, Bldg 8
Ontario, CA 91761
(888) 384-2132

CO**VALVES • MOTORS • PUMPS**

221 N Kuner Rd
Denver, CO 80601
(888) 384-2082

CT**INSPECTIONS**

2 Peerless Way
Enfield, CT 06082
(888) 384-2075

INSPECTIONS

5 Pearson Way
Enfield, CT 06082

FL**INSPECTIONS**

9911 Bavaria Rd
Fort Myers, FL 33913
(888) 384-2071

GA**COMPRESSORS**

3200 Engineering Pkwy
Alpharetta, GA 30004
(888) 384-1572

KS**MECHANICAL**

815 6th St
LeRoy, KS 66857
(888) 384-1580

KY**MACHINING**

2601 Happy Valley Rd
Glasgow, KY 42141
(888) 384-2070

LA**BOILERS**

1235 Eraste Landry Rd
Lafayette, LA 70506
(888) 384-1562

ENGINEERING

622 Burgessville Rd
Ruston, LA 71270
(888) 384-2069

FABRICATION

228 Industrial St
West Monroe, LA 71292
(888) 384-2068

PUMPS

2122 Flanacher Rd
Zachary, LA 70791
(888) 384-2124

MECHANICAL • CONSTRUCTION

400 W Main St, Ste 114
Gaylord, MI 49735
(888) 384-1573

VALVES

6809 King Ave W, #E
Billings, MT 59106
(888) 384-2102

OH**COMPRESSORS**

10349 Industrial Rd
Holland, OH 43528
(888) 384-1566

OK**VALVES**

113 Meadow Ridge Dr
Elk City, OK 73644

PA**MOTORS • PUMPS**

2850 Appleton St, Ste D
Camp Hill, PA 17011
(888) 384-2116

PUMPS

1799 Plank Rd
Carrolltown, PA 15722
(888) 384-2130

PUMPS

1095 Montour West Ind Park
Coraopolis, PA 15108
(888) 384-2126

MOTORS • PUMPS

4693 Iroquois Ave
Erie, PA 16511
(888) 384-2119

TX**VALVES**

118 Bunton St
Borger, TX 79007

VALVES

6676 Corporation Pkwy
Fort Worth, TX 76122
(888) 384-2109

CORPORATE

840 Gessner Rd
Houston, TX 77024
(888) 384-2111

VALVES • MOTORS • PUMPS

610 N Milby St
Houston, TX 77003
(888) 384-2138 VALVES
(888) 384-2133 MOTORS
(888) 384-2134 PUMPS

VALVES • MECHANICAL

117 S Parkway Dr
La Vernia, TX 78121
(888) 384-2107 VALVES
(888) 384-2103 MECHANICAL

VALVES • INSPECTIONS

3760 Kermit Hwy
Odessa, TX 79764
(888) 384-2081 VALVES
(888) 384-2072 INSPECTIONS

MECHANICAL

2711 Lilac St
Pasadena, TX 77503
(888) 384-1565

INSPECTIONS

2619 College Ave
Snyder, TX 79549
(888) 384-2073

MOTORS

465 S Main St
Vidor, TX 77662
(888) 384-2110

UT**VALVES**

2196 W 2300 St
Salt Lake City, UT 84119
(888) 384-2083

WA**VALVES**

1470 Slater Rd
Ferndale, WA 98248
(888) 384-2101

VALVES • MOTORS • PUMPS

213 Douglas St
Longview, WA 98632
(888) 384-2097

VALVES

4385 S 133rd St
Seattle, WA 98168
(888) 384-2099

WI**MECHANICAL**

21303 Omega Cir, #2
Franksville, WI 53126
(888) 384-1579



Equipment Repair & Service

Industrial Service Solutions offers in-house field, shop, and supply services for all process equipment types, brands, and applications. Our nationwide network of strategically located field technicians, engineers, and craft personnel are supported by regional shops to provide a level of service equivalent to an OEM, but quicker and more cost-effective. We have the technical expertise and application knowledge to be your single source solution for boilers, calenders, coolers, conveyors, crushers, cyclones, extruders, feeders, heat exchangers, hoppers, kilns, mills, mixers, piping, presses, motors, pumps, controls, and other process related equipment.



*Nationwide
Field Service*



*Repair, Overhaul,
& Remanufacturing*



*Outages, Shutdowns,
& Turnarounds*



*Comprehensive
Engineering*



*Onsite Machining &
Fabrication*

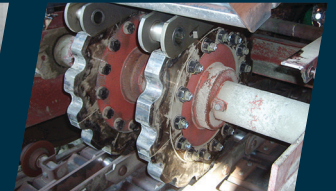

*Preventative &
Predictive Maint.*



*Specialized Rigging
& Crane Operators*



*Alternate Access &
Scaffolding Solutions*



*Extensive Inventory
of Spare Parts*

Turnkey Construction

We offer complete construction services for new builds or expansions and upgrades of existing facilities. Every aspect of a project is managed from start to finish, including concept and scope development, budgeting, engineering and design, procurement, permitting and scheduling, fabrication, construction, and post-construction hand-off. Our tenured, highly skilled engineers and field craft personnel utilize advanced technologies and processes to deliver predictable, efficient, and cost-effective construction solutions.



*Emergency Repair
& Maintenance*



*New Build &
Plant Relocation*



*Foundations &
Civil Construction*



*Complete Electrical
Installation*



Process Piping

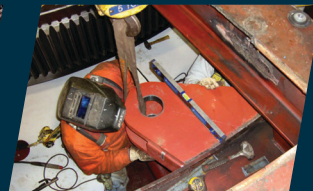

*Mechanical Service
& Installation*



*Machine Installs &
Specialized Rigging*

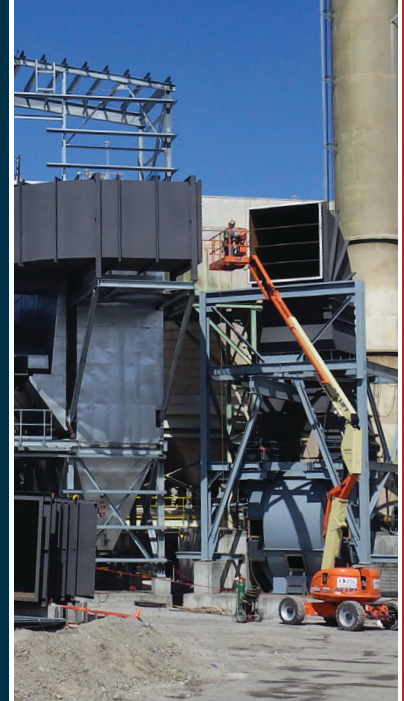

Comprehensive Engineering

Industrial Service Solutions provides fully integrated engineering services to meet our customers' most complex challenges. Our engineers have the technical knowledge to successfully transition projects from the concept and planning phase to detailed engineering and design to final completion. Engineering disciplines include civil, electrical, mechanical, piping, and structural engineering; as well as specialties such as 3D modeling and laser scanning to make projects more efficient and cost-effective.



Full-Service Project Management



Planning, Surveying, & Site Development



Civil/Structural Design & Construction



Electrical/Controls Design & Installation

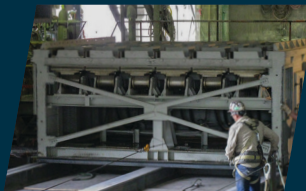

Mechanical Equip. Design & Installation



Pneumatic Systems & Process Piping



Precision Machining & Quality Fabrication

Our precision machining expertise ranges from proprietary equipment to cylindrical products and general fabrication. Experienced and highly skilled engineers and craft personnel are ready to design, prototype, and manufacture custom solutions with unmatched precision and quality to your exact specifications. We work with a variety of materials that include stainless and structural steel, aluminum, cast iron, and high alloy.



*High-Capacity Shops
with Bridge Cranes*



*Rapid Part Repair
& Manufacturing*



*CNC Drilling, Milling,
Turning, & Boring*



*ASME & AWS
Certified Welding*



*Precision Waterjet
& Flame Cutting*



*Flat Surface &
Cylindrical Grinding*



*Custom Plate Cutting,
Bending, & Rolling*



*NDT Inspections
& Testing*

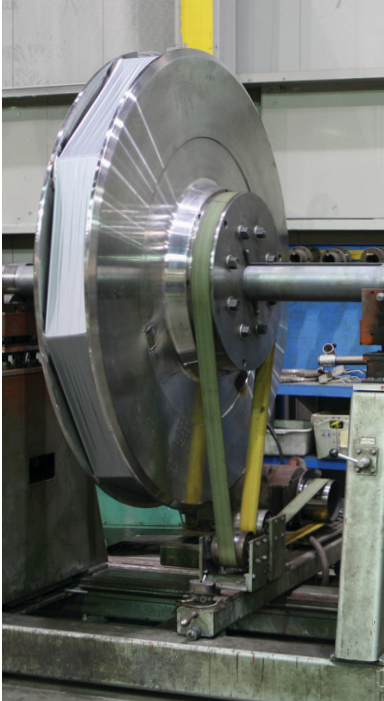

Industrial Service Solutions
 ROTATING EQUIPMENT SERVICES

Fully Equipped Repair Shops

Industrial Service Solutions provides full-service maintenance and repairs to all rotating equipment types, brands, and applications. Our UL Listed, ISO 9001:2015 certified, IEEE and EASA accredited shops are fully equipped to provide teardown, inspections, machining, fabrication, balancing, testing, and quality control services. Tenured, highly skilled technicians approach every job with an engineering mindset and specialize in never-been-done projects – if it doesn't exist, we'll create it. With end-to-end process control capability, we ensure a high-quality product that meets your exact specifications, delivered on time, and within budget.



*Repair, Overhaul,
& Remanufacturing*



*Custom Manufacturing
& Patented Designs*

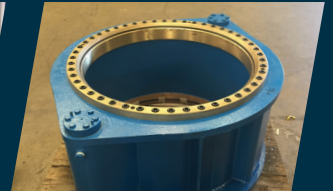

*Modifications &
Re-Engineering*

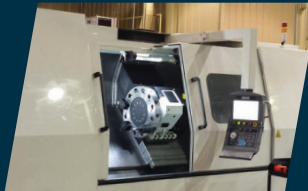

*CNC Milling, Turning,
Boring, & Grinding*



*Fabrication, Welding,
& Metal Stitching*



*Predictive Maint. &
Detailed Inspections*



*Cleaning, Degreasing,
Metalizing & Coatings*



*Extensive Inventory of
Spare Parts & Rentals*



*Equipment Storage
to OEM Specs*

MOTORS, GENERATORS, & PUMPS

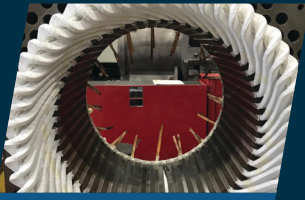

*AC & DC Rewinding
up to 20,000 HP*



*VPI Treatment with
Multi Resin Options*



*Precision Balancing
& Vibration Analysis*

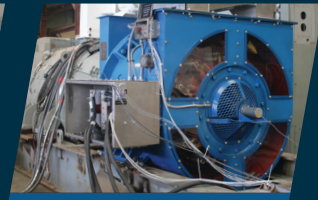

*Horizontal & Vertical
Full/No Load Testing*

COMPRESSORS

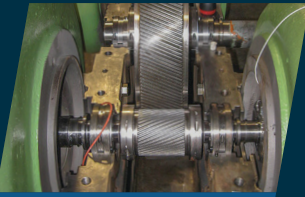

*Compressor
Overhaul & Repair*

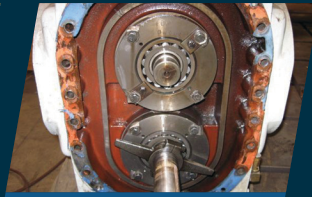

*Air End Rebuilds to
OEM Specifications*



*Cylinder, Pistons, &
Packing Case Repair*

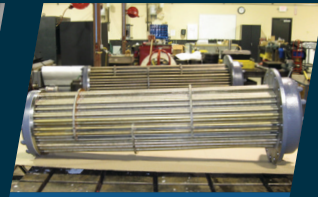

*Heat Exchanger
Retubing & Repair*

VALVES & ACTUATION



*Authorized Repairs
for most OEMs*

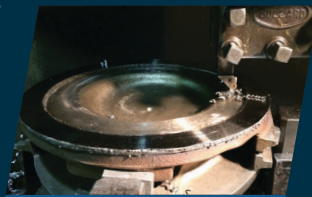

*Modifications, Conv.,
Grinding & Assembly*



*Complete Automated
Valve Packages*



*In-Line Testing for
Air, Water, & Steam*

CONTROLS & AUTOMATION

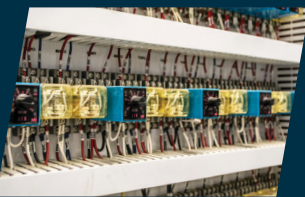

*System Integration
& Start-Up*



*Retrofit, Upgrade,
& Troubleshooting*



*SCADA, PLC, & HMI
Design/Programming*



*UL 508A & UL 698A
Panel Fabrication*

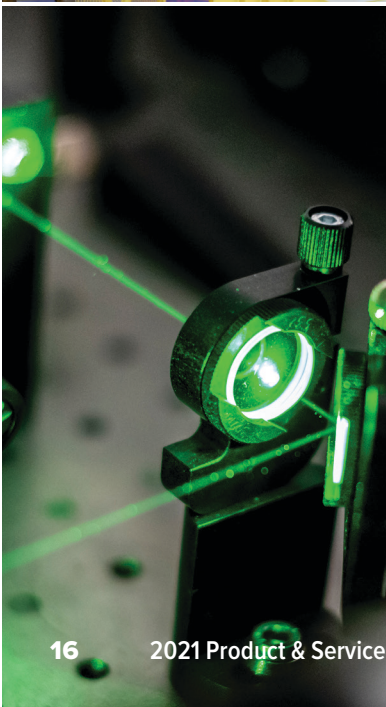

PTI Shop Inspections

PTI is one of Industrial Service Solutions' operating companies, who has proudly led the support services industry by continuously evolving their technology and setting the standard for quality, accuracy, and reliability. The wide range of services offered by PTI allows us the unique ability to be a one-stop shop for part cleaning and finishing solutions, resulting in shorter lead times, reduced transportation and administrative costs.

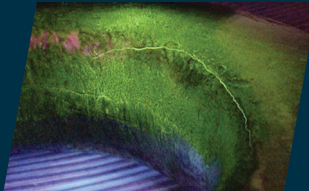

*NDT Inspections
& Testing*



*Hydraulic & Gaseous
Pressure Testing*



*Additive Component
Processing*



*Precision Cleaning
& Verification*



*Adhesive Bonding
Processes*



Dry Film Lubrication



*Magnesium Coatings
Dow 7, 17, & 9*



*Nitric & Citric Acid
Passivation*

NIC Field Inspections

NIC has the personnel, equipment, and systems in place to provide inspections and material tests at any stage of a project. Our NDT Level III Examiners are routinely called upon to develop and implement quality programs; train and certify personnel in accordance with NAS 410, ASNT-TC-1A, and ANSI/ASNT CP-189; and prepare for accreditation audits such as Nadcap, NQA-1, and ISO 9000. We can also assist in the development and implementation of your internal and vendor audit programs. Whatever your needs, we are ready to deliver services on schedule and within budget.



Construction Project Management



Technical Integrity Engineering



QA/QC Inspections API & AWS/CWI



Onsite NDT Testing & Inspection



Vendor Surveillance Audits



Corrosion Erosion Monitoring



NDT Level III Consulting Programs



QC & NDT Training

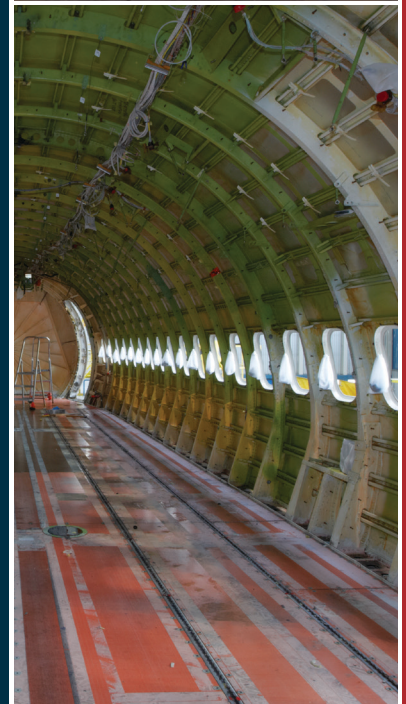
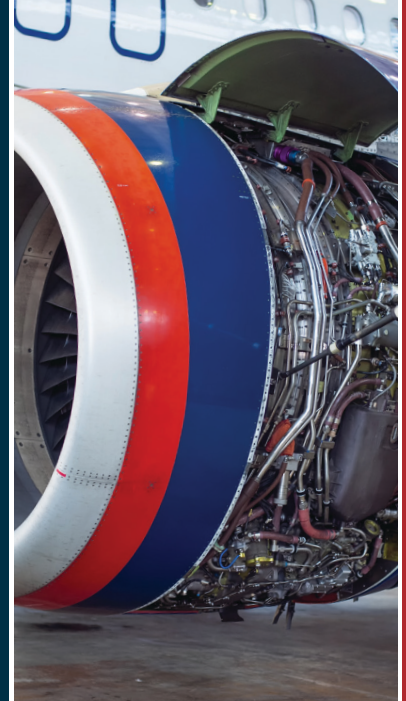



AI-Driven Asset Monitoring

Spectare is an IoT platform that remotely monitors fixed and mobile assets in real-time. Easily collect data from any piece of industrial equipment and transform it into powerful AI-driven analytics to predict potential asset failures and assign solutions before they cause downtime. Spectare allows an operator to monitor and manage assets with real-time diagnostics, condition monitoring, predictive SMS text and/or email alerts and maintenance.

BENEFITS

- + Plug-and-play, simple to use, and easy to scale
- + Real-time visibility into asset status, condition, and performance for improved uptime and field service productivity
- + Diagnose problems with AI-driven predictive notifications sent via SMS text and/or email to the right person at the right time
- + On-demand access to expert technicians who have the know-how to quickly troubleshoot, diagnose, and yield solutions remotely
- + ISNetworld® member with elite safety record and safety programs that exceed industry averages

COMPATIBILITY

- + Motors
- + Boilers
- + Other Equipment Types
- + Pumps
- + Compressors
- + Valves
- + Turbines

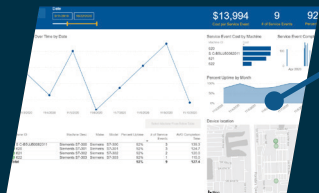

CUSTOMER DASHBOARD

Easily view and manage all assets securely and accurately from a single dashboard by phone, tablet, laptop, or desktop.

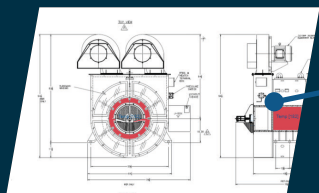

ALERTS & NOTIFICATIONS

Alert the right person at the right time by SMS text and/or email.

CONDITION MONITORING

Monitor the health and performance of assets to identify opportunities for improvement or whether to take preventative action.

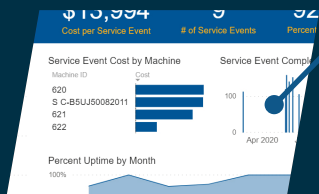

USAGE INSIGHTS

View usage costs and determine asset upgrades from real-time operating data and performance analytics.

REMOTE SUPPORT

On-demand access to expert engineers and technicians who have the know-how to quickly troubleshoot, diagnose, and yield solutions.

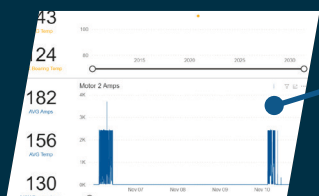

PREDICTIVE MAINTENANCE

AI algorithms determine asset's condition from real-time and historical data to predict when maintenance should be performed.

FAILURE PREDICTION

AI algorithms identify anomalous behavior and alert operators by SMS text and/or email to take preventative action.



FIELD SERVICE DISPATCHING

Tenured, highly skilled technicians with fully-equipped mobile tooling trailers are available around-the-clock for unmatched response times.



SPARE PARTS MANAGEMENT

AI algorithms provide accurate forecasting of critical spare parts needed prior to failure, when to replace, and quantity to order.

SERVICE HISTORY MANAGEMENT

Upload prior service history records and sync with future service events.

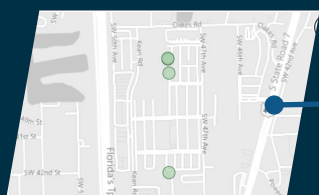

ASSET LOCATION TRACKING

Track location of assets by name, make, model, or description. For mobile machines, optional GPS tracking is available.

CONTROLS





CONTROLS
ENERGY STORAGE
MOTORS
PUMPS
VALVES
COMPRESSORS
PNEUMATICS
SAWMILLS
METAL RECYCLING
TRANSIT & RAILROAD
WATER & WASTEWATER
DIMENSIONS & MOUNTING

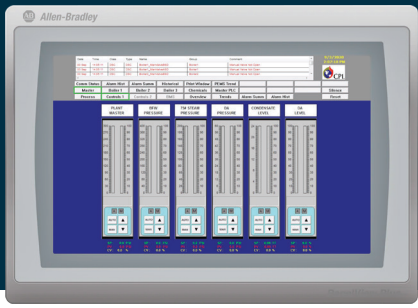

Control & Automation Systems

VFDs / Soft Starters / Controls / PLCs

Industrial Service Solutions is capable of handling and supplying all of your controls requirements and offer equipment from a large variety of industrial control manufacturers.

BRANDS WE REPRESENT

Allen-Bradley **BALDOR** **EATON** **SIEMENS** **TOSHIBA** **YASKAWA**

ABB **BENSHAW** **WEG** **Danfoss** **EMERSON** **Ward Leonard**
Applied Motor Controls Excellence in Motor and Control Solutions™



* Some brands may not be available in all geographic areas.

VARIABLE FREQUENCY DRIVES (VFDs)

We provide single-phase and three-phase VFDs for a variety of AC and DC applications, from small electric motors to high power induction motors.



SOFT STARTERS

We utilize soft starters to ensure the best performance for each application. They allow motors to start and stop in a smooth and efficient way, which protects the motor and the load from torque shocks or jolts.



CONTROLS

Our controls take your machines to the next level of performance. They can be tailored to any machine make or model and are free of restrictions on configurations, customizations, and data access.



PROGRAMMABLE LOGIC CONTROLLERS (PLCs)

Optimize panel space and simplify maintenance jobs by replacing auxiliary contactors, timers, and counters with PLCs designed for interlocking, timing, counting, and math operation tasks at high-speed.



CONTROLS

ENERGY STORAGE

MOTORS

PUMPS

VALVES

COMPRESSORS

PNEUMATICS

SAWMILLS

METAL RECYCLING

TRANSIT & RAILROAD

WATER & WASTEWATER

DIMENSIONS & MOUNTING



Custom Panels Designed & Fabricated

Certified UL 508A Panel Shop

AC DRIVE / VFDs SYSTEMS

We provide AC variable frequency drives (VFDs) for heavy-duty industrial applications in the most harshest of environments. We are a systems integrator providing tailored solutions to your exact specifications.

DC DRIVE / SCR SYSTEMS

We have over 40 years experience in SCR drive design. This allows us to provide SCR systems of any size and complexity. All components of our designed SCR systems are generic and not proprietary.

GENERATOR CONTROL PANELS

Our controls utilize Woodwardor Basler Generator Control Modules, which facilitate engine control, synchronization, kW load control, re-active (KVAR) control, automatic generator sequencing, generator and engine protection, and communication interface and display.

MOTOR CONTROL CENTERS (MCCs)

We can integrate any system on the market. Our motor control centers are customized to match your equipment. We can package MCCs inside e-houses that come pre-wired and ready to use.

SWITCHGEAR CABINETS

We build low, medium, and high voltage switchgears for heavy-duty applications. Our switchgears are built to your specifications and meet all regulatory requirements.



CONTROLS

ENERGY STORAGE

MOTORS

PUMPS

VALVES

COMPRESSORS

PNEUMATICS

SAWMILLS

RECYCLING

TRANSIT & RAILROAD

WATER & WASTEWATER

DIMENSIONS & MOUNTING



Custom E-Houses & Power Distribution Centers

Mobile / Semi-Mobile / Fixed / Skid / Onboard

APPLICATIONS

- + Mining & Metals
- + Oil & Gas
- + Power Generation
- + Processing Industries

Industrial Service Solutions integrates complete electrical and automation systems to specification and packages them in custom e-houses, control consoles, and containers. Each unit is delivered assembled, interconnected, and fully tested at the factory. There are no size limitations and can be used in many different environments, from the arctic to the tropics.

COMPONENTS

- + Medium voltage switchgear and controls
- + Medium and low voltage Motor Control Centers (MCCs)
- + Dry and oil transformers
- + Control panels and protection relays
- + Air conditioning and pressurization systems
- + Fire detection and extinguishing system
- + UPS system back-up integration, battery banks and rectifiers
- + Medium and low voltage soft starters and frequency inverters
- + Automation system, including supervisory and control stations
- + DC SCR system for drilling applications
- + AC variable speed drives
- + PLC and field networks
- + Auxiliary panels

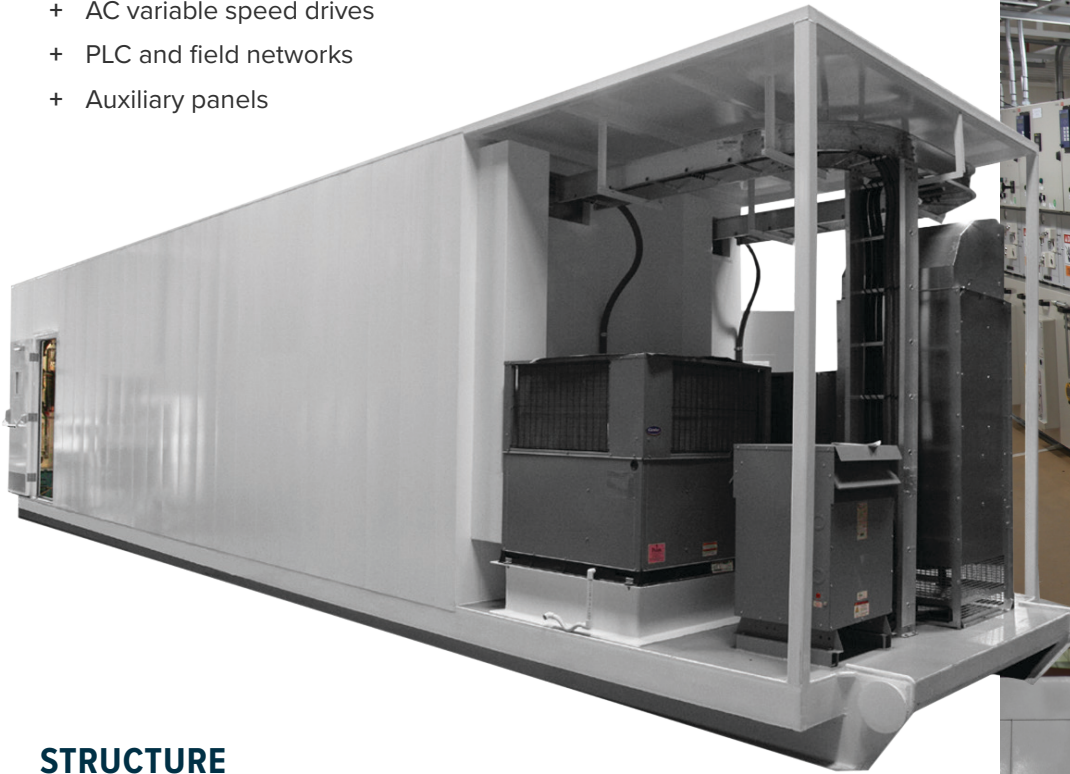

STRUCTURE

- + Wall, ceiling, and roof frames made from square steel tubes
- + Thermal insulated walls and ceiling constructed from steel galvanized sheets and rock wool
- + Thermal insulated doors with stainless steel hinges
- + Weld and painting processes inspected by accredited personnel
- + Options: gutters, platforms, catwalks, ladders, railings, hand rails, anti-slip floor paint, and acid/corrosion resistant coating

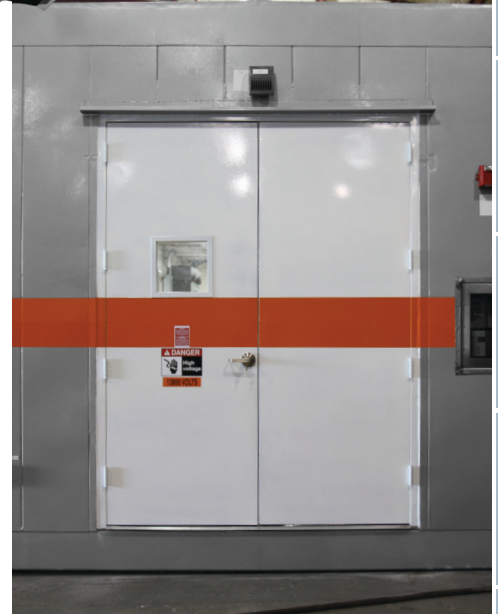

CONTROLS

ENERGY STORAGE

MOTORS

PUMPS

VALVES

COMPRESSORS

PNEUMATICS

SAWMILLS

METAL RECYCLING

TRANSIT & RAILROAD

WATER & WASTEWATER

DIMENSIONS & MOUNTING



Replacement Parts for Control Panels



Circuit Breakers

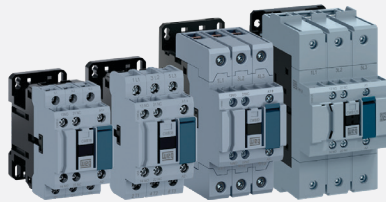

Contactors



Relays



Push Buttons



Pilot Lights



Switches

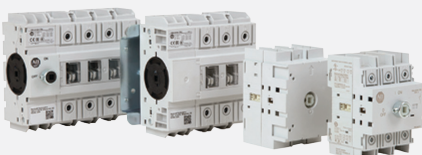

Quick Disconnects

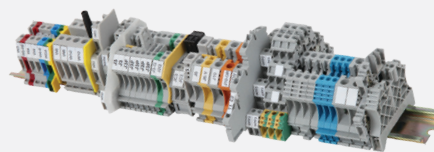

Terminal Blocks

Other Spare Parts

BRANDS WE REPRESENT

Allen-Bradley **SIEMENS** **TOSHIBA** **YASKAWA** **BENSHAW**
Applied Motor Controls

ABB **WEG** **Danfoss** **EMERSON**

* Some brands may not be available in all geographic areas.



Generators

30kW – 5000kW

New & Remanufactured

We provide both new and remanufactured generators from 30kW to 5000kW. Generators can be built from 240V to 12kV. All generators are built to strict industry standards and customer specifications and come with a one year parts and labor warranty.

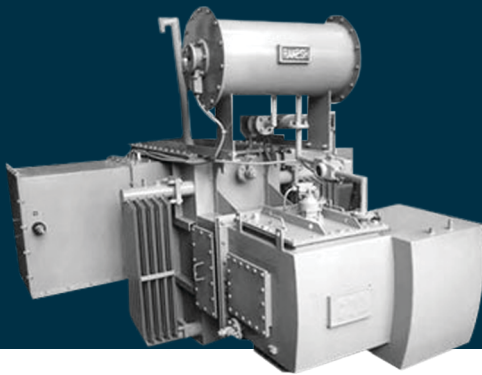

Transformers

New & Remanufactured

We provide transformers for almost every type of application. Our staff can assist you in choosing a designed transformer to meet your individual factors such as voltage, power, climate, system topography, sound level, and many more.

BRANDS WE REPRESENT



ENERGY STORAGE



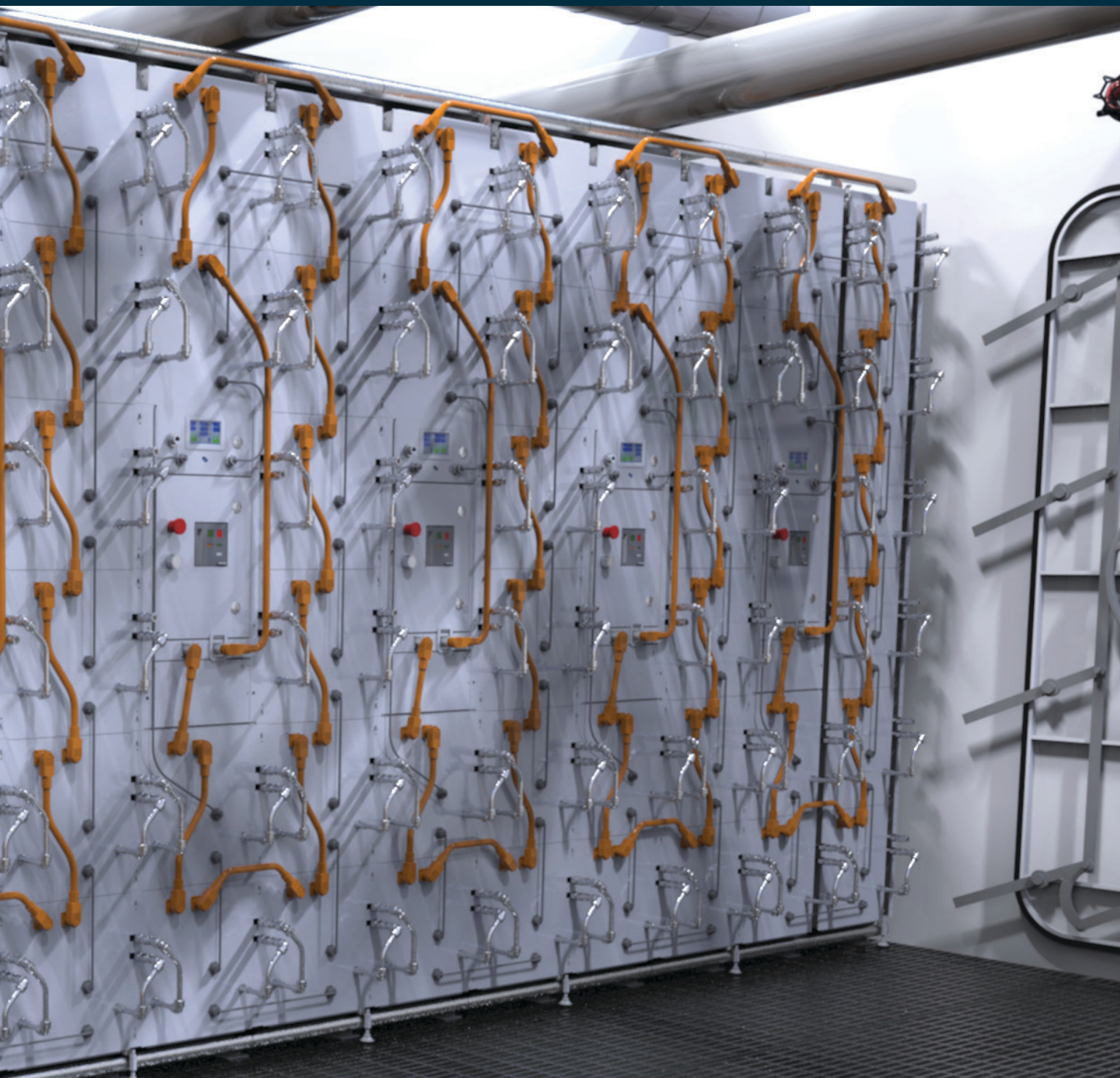

Industrial Service Solutions

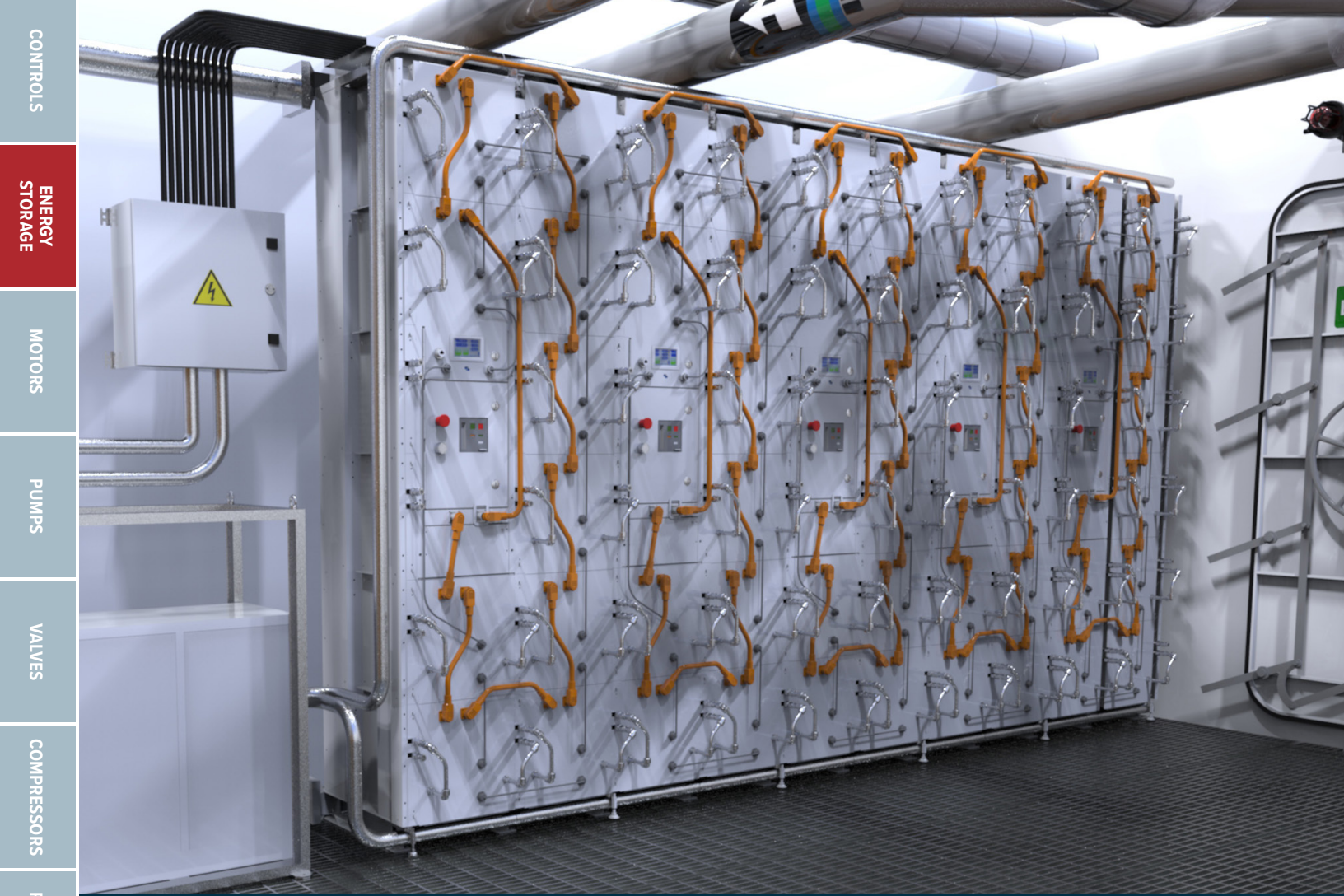

SHIFT

+ 2 CLEAN ENERGY

Highest energy density cells on the market



Shift delivers clean energy solutions based on leading-edge energy storage systems. Meeting climate action goals through electrification and unlocking the potential of new technologies through hybrid solutions, making low and zero-emissions operations a reality-today. Our unique innovations deliver quality ESS that can be used safely and efficiently for the lifespan of a vessel.

- CONTROLS
- ENERGY STORAGE
- MOTORS
- PUMPS
- VALVES
- COMPRESSORS
- PNEUMATICS
- SAWMILLS
- METAL RECYCLING
- TRANSIT & RAILROAD
- WATER & WASTEWATER
- DIMENSIONS & MOUNTING

FEATURES

- + MegaWatt ++ Battery Management System
- + API Interface
- + 5/10 Year Engineered Design Life
- + CellCool™ Liquid Cooling
- + TCP Ultra Fast Internal Comms
- + Thermal-Stop™ Thermal Runaway Protection
- + E-Vent™ Safety Venting System
- + 59°F to 86°F Operating Temperature
- + -104°F to +140°F Operating Ambient Temperature Range
- + 68°F to 77°F Internal Active Working Temperature
- + Series Configurable
- + OnPoint™ Remote Active Monitoring & Programming

SINGLE MODULE BBU	POWER 66	POWER 75	ENERGY 88
C Rate RMS (Continuous)	3C	3C	1C
Cycle Life @ 80% DoD	15,000 Cycles	15,000 Cycles	13,000 Cycles
Cell Chemistry	NMC	NMC	NMC
Dimensions	L 580mm, H 380mm, W 320mm	L 580mm, H 380mm, W 320mm	L 580mm, H 380mm, W 320mm
Weight	93 kg	93 kg	205 lbs
Energy	6.6 kWh	7.5 kWh	8.8 kWh
Capacity	75 Ah	85 Ah	100 Ah
Voltage Range	77-100 VDC	77-100 VDC	77-100 VDC
Nominal Voltage	88.8 VDC	88.8 VDC	88 VDC
RMS Continuous Current	225A	225A	100A
Max Discharge Current	450A	450A	200A
Max Charge Current	225A	225A	100A
Connectors	IP67	IP67	IP67
Terminal Isolation at Module	Contactator	Contactator	Contactator
Thermal-Stop™ Thermal Runaway Protection	Yes	Yes	Yes
Self Discharge Rate/Month	<2%	<2%	<2%
Internal Resistance	13.2mΩ	9.6mΩ	13.2mΩ
Efficiency (at 1C)	>98%	>98%	>98%
Electrical Isolation	Open circuit when not in operation	Open circuit when not in operation	Open circuit when not in operation
Communication Interface	UDP	UDP	UDP
SERIES STRING (1000V)	POWER 66	POWER 75	ENERGY 88
Dimensions (Racking, Venting, & Lifting Apparatus)	W 896mm, H 2550mm, D 632mm	W 896mm, H 2550mm, D 632mm	W 896mm, H 2550mm, D 632mm
Weight	1,265 kg	1,265 kg	1,265 kg
Energy	66 kWh	75 kWh	88 kWh
Capacity	75 Ah	85 Ah	100 Ah
Voltage Range	770-1000 VDC	770-1000 VDC	770-1000 VDC
Nominal Voltage	888 VDC	888 VDC	880 VDC
RMS Continuous Current	225A	225A	140A

MOTORS

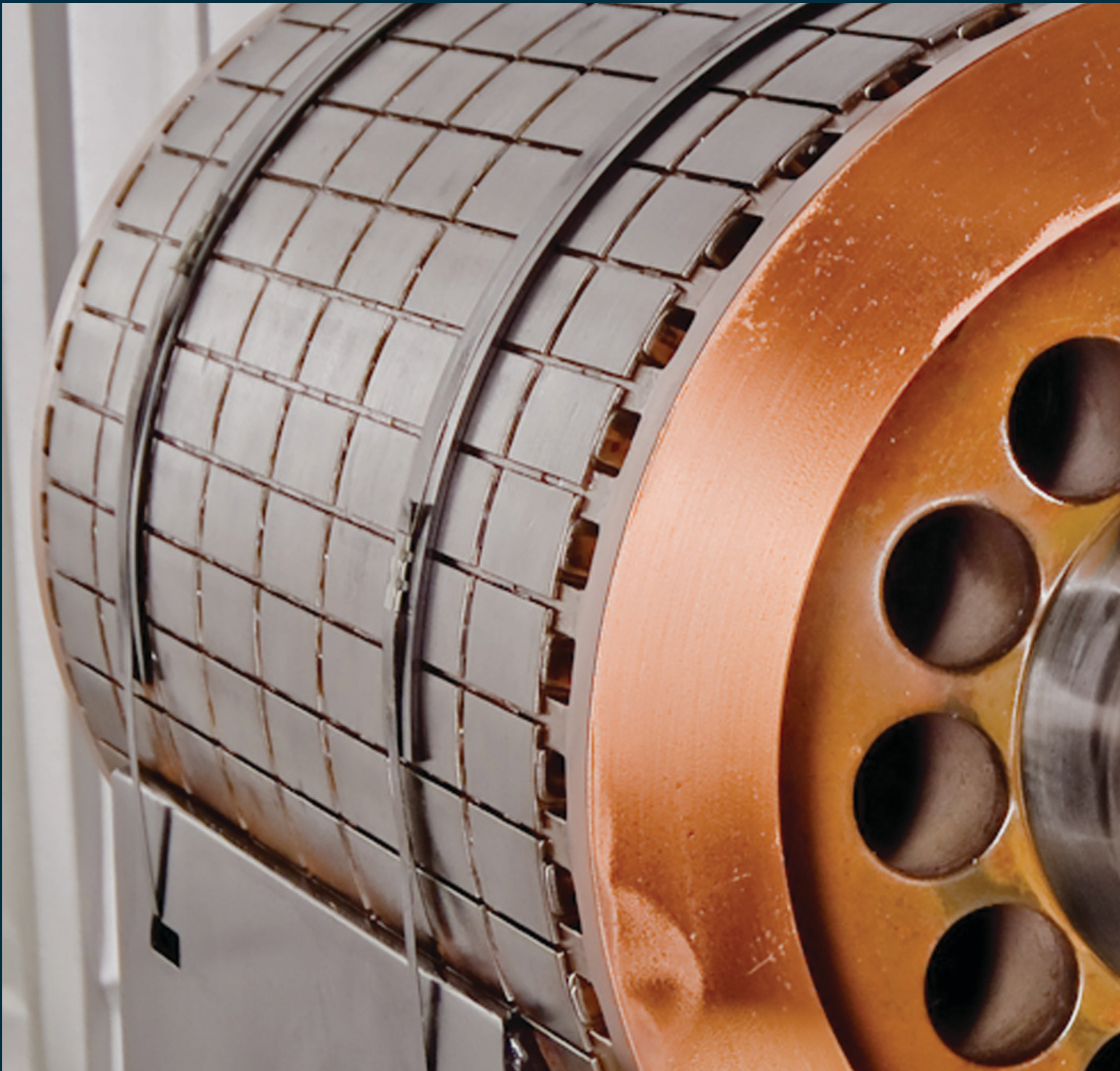

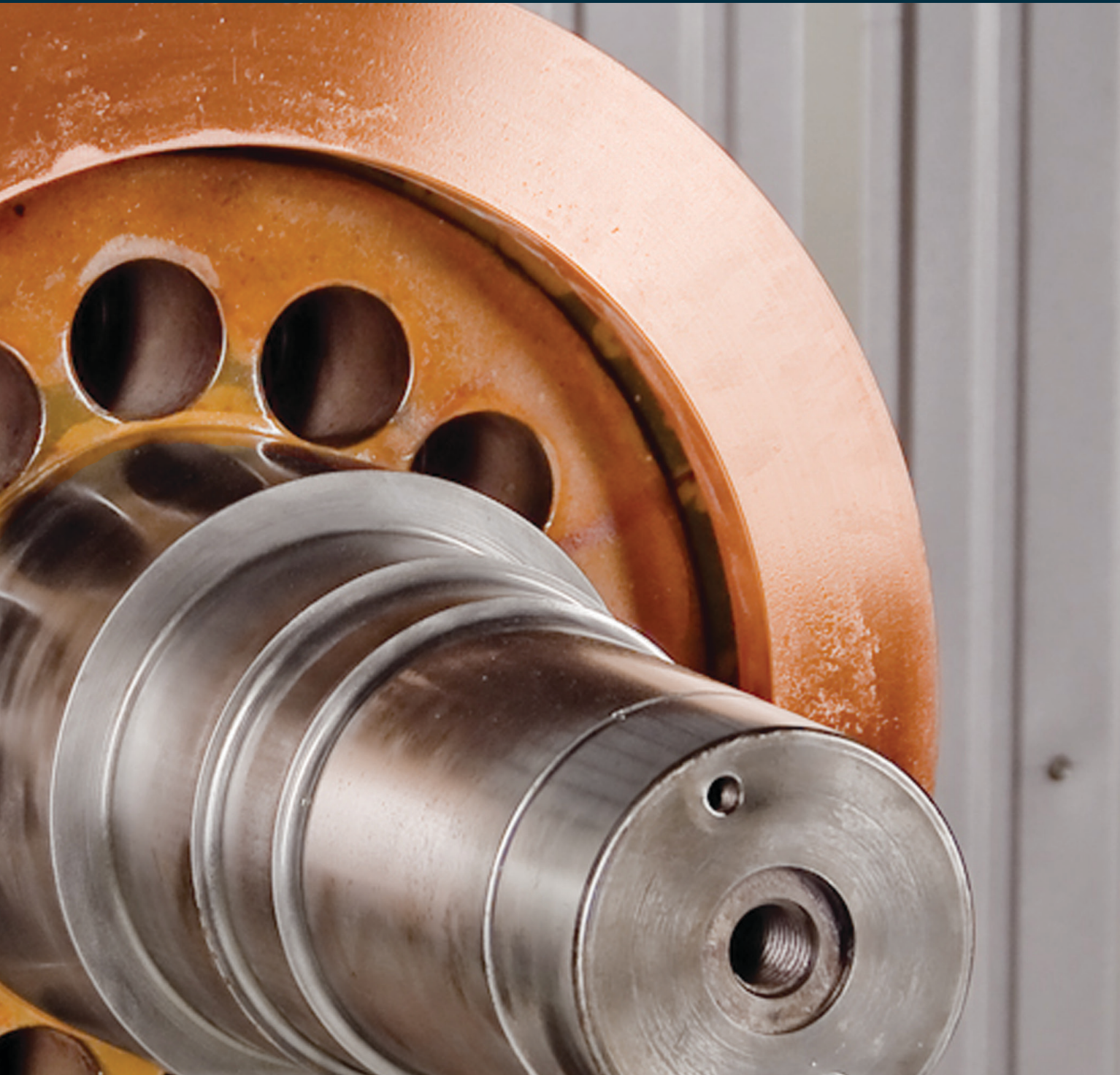

Industrial Service Solutions

CONTROLS

ENERGY STORAGE

MOTORS

PUMPS

VALVES

COMPRESSORS

PNEUMATICS

SAWMILLS

METAL RECYCLING

TRANSIT & RAILROAD

WATER & WASTEWATER

DIMENSIONS & MOUNTING

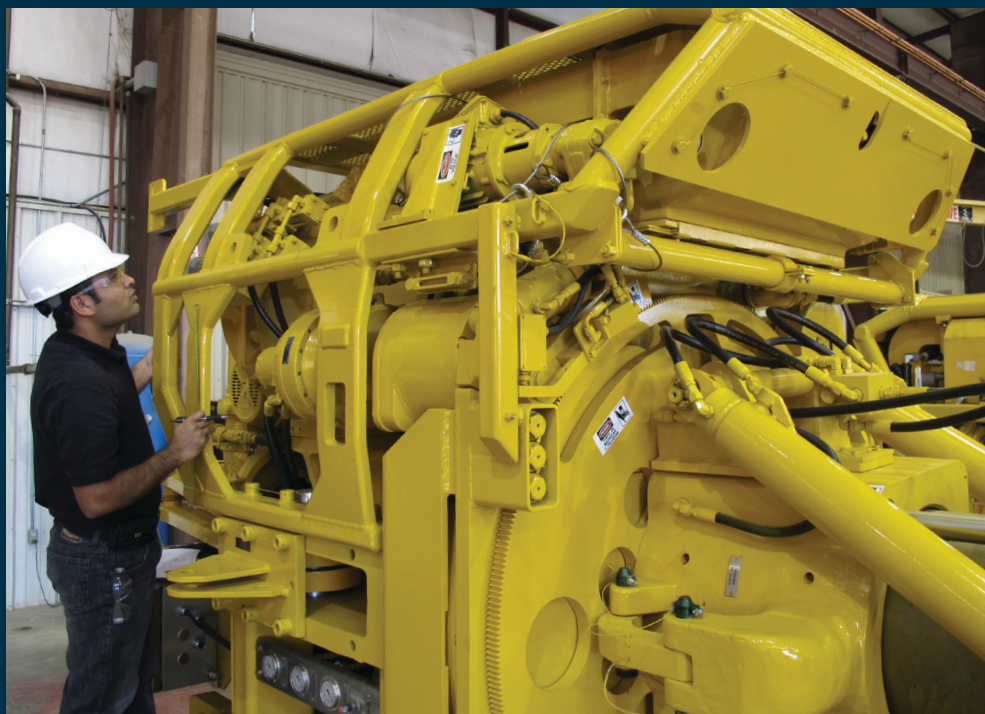
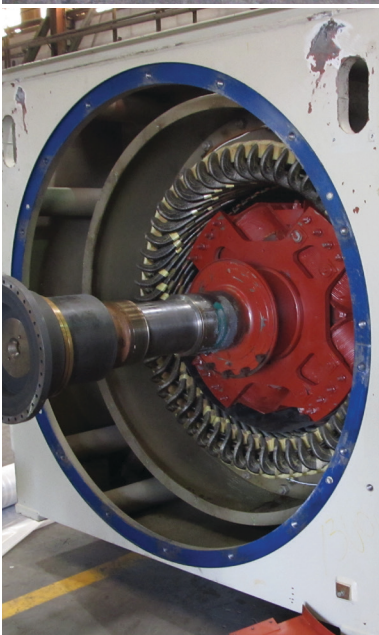
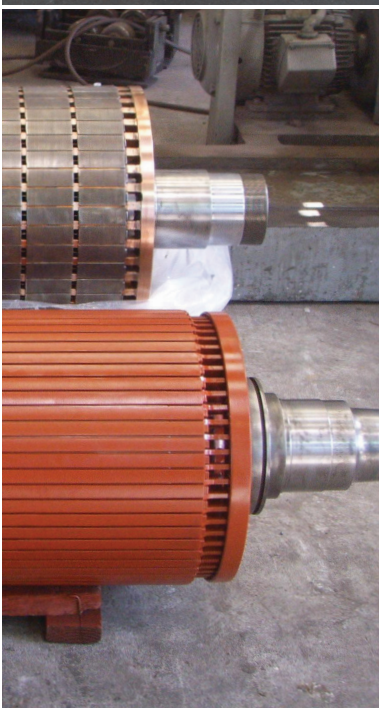

Motor & Generator Repairs, Rebuilds, & Upgrades

Industrial Service Solutions specializes in full-service repairs, rebuilds, and upgrades for all rotating equipment types, brands, and applications, from fractional horsepower to assets weighing hundreds of tons. Our facilities are fully equipped to provide teardown, inspection, evaluation, machining, fabrication, welding, balancing, testing, and quality control services. With end-to-end process control capability, we ensure a high-quality product that meets your exact specifications, delivered on time and within budget.

- + *Single & Three Phase*
- + *AC Squirrel Cage*
- + *AC Wound Rotor*
- + *AC Brushless*
- + *AC Slip Ring*
- + *DC Series*
- + *DC Shunt*
- + *Servo Motors*
- + *Specialty Motors*
- + *Explosion-Proof*
- + *UL-Approved*
- + *Generators*
- + *Transformers*

Motor Rewinds & In-House Coil Manufacturing

We specialize in complete electric motor rewinding and our engineers offer a variety of coil designs and re-engineering services for higher efficiency and reliability. At Industrial Service Solutions, we comply with EASA and IEEE standards for rewinds and have CNC looping, taping, and forming machines for accurate and consistent results. Our regional repair shops are climate controlled with burn off ovens, vacuum pressure impregnation systems, and we manufacture coils in-house for absolute control over quality and lead times.

- + *Wire Wound Stators & Rotors*
- + *Squirrel Cage Rotor Bars*
- + *Brake & Clutch Coils*
- + *Variable Speed Motors*
- + *Slip Ring Motors & Rotors*
- + *Soft & Formed Coil Stators*
- + *Commutators*
- + *Field Coils*
- + *Armature Coils*
- + *Interpoles*
- + *Shunt Coils*



CNC Looping



CNC Taping



CNC Pre-Forming

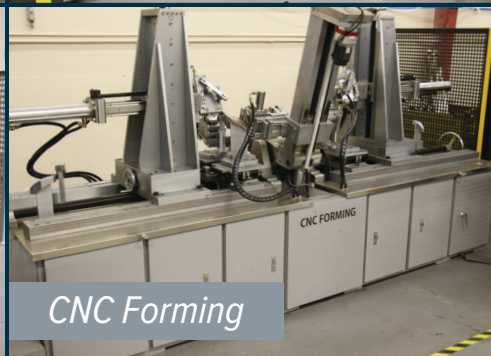

CNC Forming

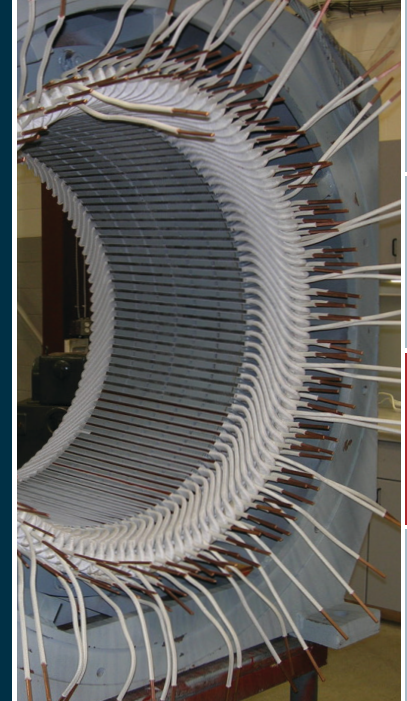

CONTROLS

ENERGY STORAGE

MOTORS

PUMPS



VALVES

COMPRESSORS

PNEUMATICS

SAWMILLS



METAL RECYCLING

TRANSIT & RAILROAD

WATER & WASTEWATER

DIMENSIONS & MOUNTING

CONTROLS
ENERGY STORAGE
MOTORS
PUMPS
VALVES
COMPRESSORS
PNEUMATICS
SAWMILLS
METAL RECYCLING
TRANSIT & RAILROAD
WATER & WASTEWATER
DIMENSIONS & MOUNTING



Comprehensive Testing

Industrial Service Solutions has one of the largest ISO 9001-2015 testing facilities in North America. We provide full load testing up to 6,000 HP and no load testing up to 25,000 HP at 15kV for both horizontal and vertical mounted motors. Our in-house engineers utilize state-of-the-art equipment, to comply with EASA and IEEE standards, and can meet any customer specification. Motor, generator, drive, and transformer testing capabilities include, but are not limited to:

- + AC Line Test up to 4,160 V
- + DC Line Test up to 600 V
- + No Load Test up to 25,000 HP
- + Full Load Test up to 6,000 HP
- + Computerized Core Loss Test
- + Insulation Resistance Test
- + Polarization Index Test
- + Hi-Pot Test up to 15 kV
- + Surge Comparison Test
- + AC & DC Voltage Drop Test
- + PdMA MCE Test
- + Armature Bar-to-Bar Test
- + Field Coil Polarity Test
- + High Current Rotor Test
- + Winding Resistance Test (Wheatstone Bridge)

COMPUTER RECORDINGS

- + Voltages
- + HP / kW
- + Speed
- + Temperature Rise
- + Currents
- + Efficiency
- + Vibration
- + Thermo Imaging

Custom Manufacturing

We design, engineer, manufacturer, and service high-performance power systems for high-demand industrial applications. Our patented designs and proprietary processes deliver cost-effective solutions that last up to five years longer than our competition. We specialize in never-been-done projects – if it doesn't exist, we can develop it. From unique electrical and mechanical specifications to weight and footprint requirements, our highly skilled engineers provide innovative solutions to meet your exact needs.



Nationwide Field Services

Industrial Service Solutions' nationwide network of field experts and fully equipped service vehicles, including 53-foot mobile tooling trailers, are available around-the-clock for your unplanned maintenance and emergency repairs. Our tenured, highly skilled technicians have the know-how and independent capabilities to troubleshoot, diagnose, and yield solutions for all rotating equipment types, brands, and applications. At Industrial Service Solutions, our personnel are supported by a flex workforce of vetted talent for unmatched response and turnaround times.

- + Turnarounds, Shutdowns, & Outages
- + Preventative Maintenance
- + Start-up & Troubleshooting
- + Equipment Repairs & Overhauls
- + Electrical & Mechanical Repair
- + Specialty Rigging & Installation
- + Machining & Part Fabrication
- + Preventative Maintenance
- + Cryogenic Cleaning & Degreasing
- + Turnkey Project Services
- + Onsite Maintenance
- + Non-Destructive Testing
- + Laser & Optical Alignment
- + Performance Testing
- + Vibration Analysis
- + Dynamic Balancing
- + Infrared Thermal Imaging
- + Onsite Bearing Replacement

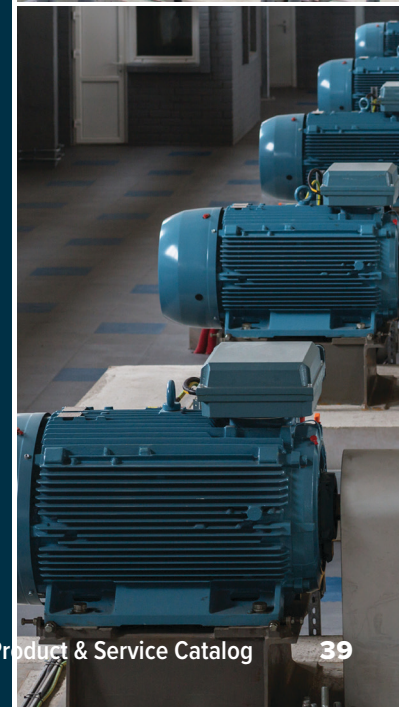
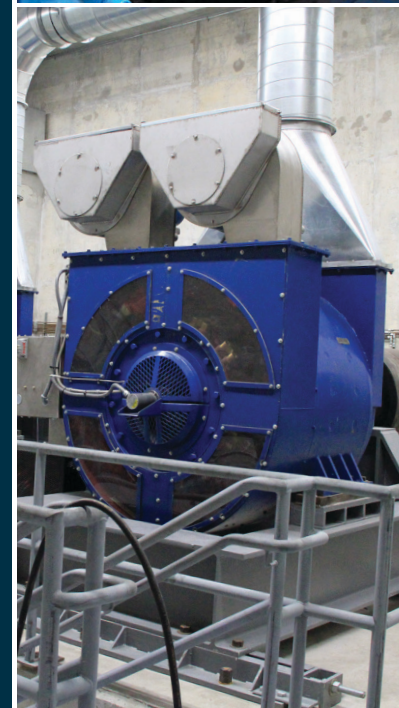
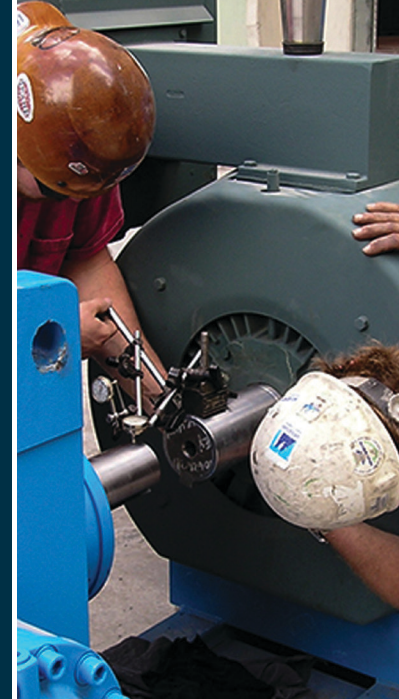

CONTROLS

ENERGY STORAGE

MOTORS

PUMPS

VALVES

COMPRESSORS

PNEUMATICS

SAWMILLS

METAL RECYCLING

TRANSIT & RAILROAD

WATER & WASTEWATER

DIMENSIONS & MOUNTING

Brands We Represent

Industrial Service Solutions is a manufacturer and distributor of AC and DC motors, from fractionals to 5,000 HP and above. We provide distribution for the major OEMs below.



* Some brands may not be available in all geographic areas.



Dominator AC Motors

Horizontal & Vertical Mount



APPLICATIONS

- + Cement & Aggregates
- + Chemical & Petrochemical
- + Marine & Dredging
- + Mining & Metals
- + Municipal
- + Oil & Gas
- + Pulp & Paper
- + Power Generation
- + Recycling
- + Tire & Rubber

HP	TORQUE	RPM	VOLTS	FREQ	AMPS
400	2,632 ft lbs	798	575*	45 Hz	367
800	5,305 ft lbs	792	550*	40 Hz	762
1,150	7,626 ft lbs	792	565*	40 Hz	1,115
1,350	8,963 ft lbs	791	550*	40 Hz	1,345
1,500	9,985 ft lbs	789	550*	40 Hz	1,494
1,600	10,650 ft lbs	789	550*	40 Hz	1,585
1,750	11,634 ft lbs	790	575*	40 Hz	1,658
2,000	13,262 ft lbs	792	575*	45 Hz	1,895
2,400	14,005 ft lbs	900	575*	45 Hz	2,286

Medium voltage, various RPMs, & larger HP designs available. *Can be wound 480V, 600V, 690V, 2300V, & 4160V



Motors can be vertically mounted

Certifications Available:



Center mounted stainless steel junction box allows cable entry from left or right side, with copper bus bar, terminal strip for low voltage connection, lockout switch, and pressure switch. Junction box rated IP56.

Form wound stator with vented laminations for superior cooling

Unique superior cooling system utilizes the Eliminator Blower made from Stainless Steel

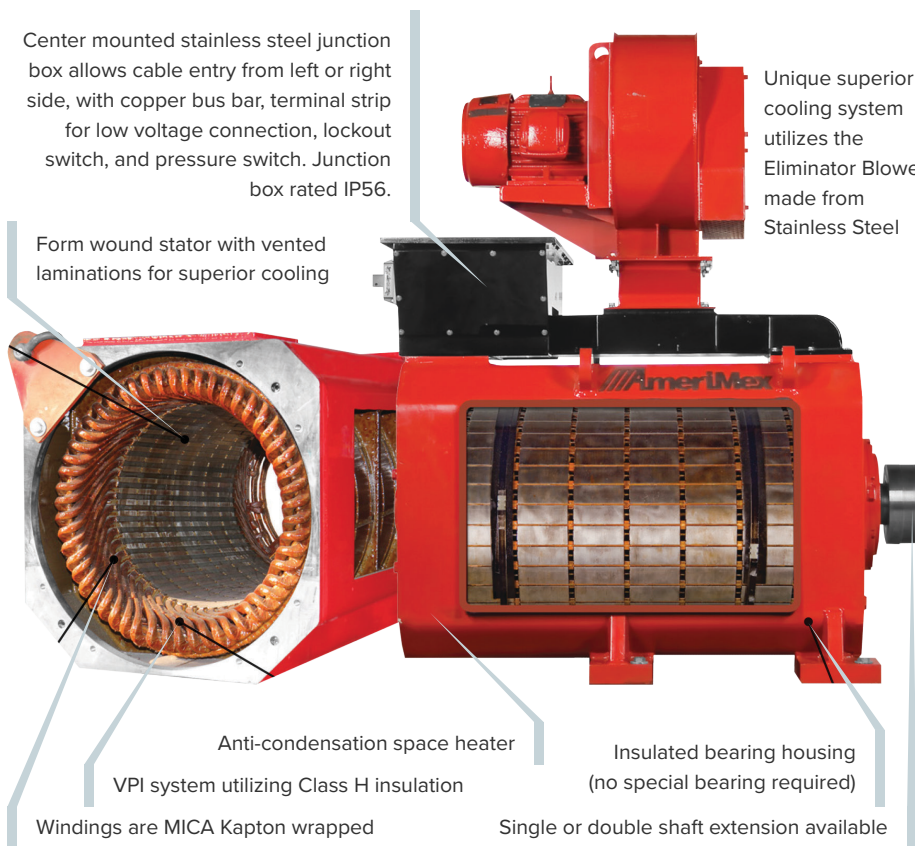

Anti-condensation space heater

Insulated bearing housing (no special bearing required)

VPI system utilizing Class H insulation

Windings are MICA Kapton wrapped

Single or double shaft extension available



Dominator Marine Motors

Horizontal & Vertical Mount

APPLICATIONS

- + Dredging
- + Marine

HP	TORQUE	RPM	VOLTS	FREQ	AMPS
400	1,166 ft lbs	1,800	690	60 Hz	309
600	1,750 ft lbs	1,800	690	60 Hz	464
800	2,333 ft lbs	1,800	690	60 Hz	620
1,150	3,354 ft lbs	1,800	690	60 Hz	892
1,500	4,375 ft lbs	1,800	690	60 Hz	1,163
2,000	5,833 ft lbs	1,800	690	60 Hz	1,550
2,500	7,291 ft lbs	1,800	690	60 Hz	1,938
3,000	8,750 ft lbs	1,800	690	60 Hz	2,325
4,000	11,666 ft lbs	1,800	690	60 Hz	3,099
5,000	14,583 ft lbs	1,800	690	60 Hz	3,875

Medium voltage, various RPMs, and larger HP designs available.

FEATURES

- + Center mounted stainless steel junction box allows cable entry from left or right hand side, with copper bus bar, terminal strip for low voltage connection, lockout switch and pressure switch. Resistance temperature detectors connection point. Junction box is rated IP56.
- + Unique closed-loop cooling system
- + Form wound stator with vented laminations for superior cooling
- + Anti-condensation space heater
- + VPI system utilizing Class H insulation
- + Windings are MICA Kapton wrapped
- + Insulated bearing housing (no special bearing required)
- + Single or double shaft extension available

Certifications Available:



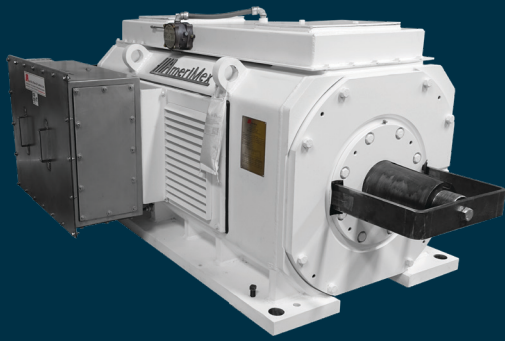

Dominator Mining Motors

Horizontal & Vertical Mount

APPLICATIONS

- + Boring
- + Conveyors
- + Crane & Hoist
- + Drag Lines
- + Rock Crushers
- + Rock Saws
- + Calcining Kilns
- + Drying Kilns

HP	TORQUE	RPM	VOLTS	FREQ	AMPS
400	2,632 ft lbs	798	575	45 Hz	367
800	5,305 ft lbs	792	550	40 Hz	762
1,150	7,626 ft lbs	792	565	40 Hz	1,115
1,350	8,963 ft lbs	791	550	40 Hz	1,345
1,500	9,985 ft lbs	789	550	40 Hz	1,494
1,600	10,650 ft lbs	789	550	40 Hz	1,585
1,750	11,634 ft lbs	790	575	40 Hz	1,658
2,000	13,262 ft lbs	792	575	45 Hz	1,895
2,400	14,005 ft lbs	900	575	45 Hz	2,286

Medium voltage, various RPMs, and larger HP designs available. Please consult factory for details.

FEATURES

- + Center mounted stainless steel junction box allows cable entry from left or right hand side, with copper bus bar, terminal strip for low voltage connection, lockout switch and pressure switch. Resistance temperature detectors connection point. Junction box is rated IP56.
- + Form wound stator with vented laminations for superior cooling
- + Insulated bearing housing (no special bearing required)
- + Unique closed-loop cooling system
- + Anti-condensation space heater
- + VPI system utilizing Class H insulation
- + Windings are MICA Kapton wrapped
- + Single or double shaft extension available



Certifications Available:





Enforcer AC Motors

Horizontal & Vertical Mount

APPLICATIONS

- + Cement & Aggregates
- + Chemical & Petrochemical
- + Marine & Dredging
- + Mining & Metals
- + Municipal
- + Oil & Gas
- + Pulp & Paper
- + Power Generation
- + Recycling
- + Tire & Rubber

HP	TORQUE	RPM	VOLTS	FREQ	AMPS
2,500	16,406 ft lbs	800	690*	40 Hz	1,940
2,850	18,703 ft lbs	800	690*	40 Hz	2,208
3,000	19,687 ft lbs	800	690*	40 Hz	2,325
5,000	32,812 ft lbs	800	690*	40 Hz	3,785
6,000	39,375 ft lbs	800	690*	40 Hz	4,650
10,000	65,625 ft lbs	800	690*	40 Hz	7,750

Medium voltage, various RPMs, and larger HP designs available.

*Can be wound to 480V, 600V, 690V, 2300V, and 4160V

FEATURES

- + Class H insulation
- + 50°C Ambient Temperature
- + Wye connection
- + VPI form wound coils
- + Ingress Protection IP44 (Open)
- + EExe Heaters installed
- + (6) 100 Platinum RTDs installed on windings (2 per phase)
- + Double tapered shaft
- + Slotted foot
- + Seals & bearing caps
- + Certified outline drawing
- + Certificate of compliance

Certifications Available:





Revolution AC Motors

Horizontal & Vertical Mount / Top Drive

APPLICATIONS

- + Cement & Aggregates
- + Chemical & Petrochemical
- + Marine & Dredging
- + Mining & Metals
- + Municipal
- + Oil & Gas
- + Pulp & Paper
- + Power Generation
- + Recycling
- + Tire & Rubber

HP	TORQUE	RPM	VOLTS	FREQ	AMPS
350	1,531 ft lbs	1,200	575	40 Hz	325
400	1,750 ft lbs	1,200	575	40 Hz	372
500	2,187 ft lbs	1,200	575	40 Hz	465
550	2,406 ft lbs	1,200	575	40 Hz	512
600	2,625 ft lbs	1,200	575	40 Hz	558

Medium voltage, various RPMs, and larger HP designs available.

FEATURES

- + Form wound 5kV stator windings control voltage spikes from long lead cables
- + Copper bar rotor construction (no die cast aluminum rotors used)
- + Heavy duty bearings for mechanical strength
- + Heat sink formed in stator for better heat dissipation
- + Optional cable leads or terminal block configuration with copper bus bar construction
- + Heavy duty end rings for high current carrying capacity
- + Heavy duty snap rings to keep the rotor from dropping on brake pads
- + Steel housing, retaining spring, and keeper
- + Upgraded heavy load bearing arrangement
- + 5kV lead cable
- + VPI Class H insulation
- + Double tapered shaft
- + DPFV enclosure
- + Safety wired
- + With covers
- + With brake hub



Certifications Available:



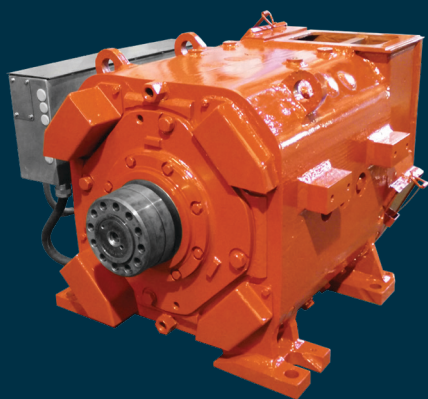

Custom DC Motors

New & Remanufactured

APPLICATIONS

- + Cement & Aggregates
- + Chemical & Petrochemical
- + Marine & Dredging
- + Mining & Metals
- + Municipal
- + Oil & Gas
- + Pulp & Paper
- + Power Generation
- + Recycling
- + Tire & Rubber

FEATURES

- + Custom built up to 5,000 HP
- + Eliminator cooling blower removes contaminants
- + Loss of blower protection device
- + Oversized junction box with copper bushbars
- + Full load tested
- + SCR Duty
- + Precision balance for low vibration
- + Removable commutator cover
- + Emergency replacement parts readily available
- + Two year warranty and 24/7 field service

OPTIONS

- + Safety lockout device
- + Vertical configuration
- + Explosion proof air pressure switch
- + TEWAC cooling for low noise operation
- + Copper split bearings
- + Double shaft
- + RTDs
- + Tachometer generator
- + Filtration package (5 micron or less)
- + Spare parts kit: 2 commutator coils, 2 shunt fields, 2 brush studs, 2 sets of brushes



Certifications Available:





Eliminator Cooling Blowers

Vertical & Horizontal Mount

APPLICATIONS

- + Dirty & Enclosed Environments
- + Chemical & Petrochemical
- + Marine & Dredging
- + Mining & Metals
- + Plastic & Extruding
- + Pulp & Paper

The patented, high-capacity Eliminator Cooling Blower is the most efficient blower on the market due to its unique blade design that centrifugally removes contamination from the air without the use of filters.

HP	RPM	FREQ	CFM	PRESSURE
10	1,800	60 Hz	2,600	5
10	3,000	50 Hz	2,500	7
10	3,600	60 Hz	2,200	5
15	1,800	60 Hz	2,800	5
15	3,000	50 Hz	-	-
15	3,600	60 Hz	2,800	5
20	3,600	60 Hz	3,500	5

FEATURES

- + Eliminates premature failure on AC and DC motors caused by contamination
- + Leads industry in noise level with vertical or horizontal mounting options
- + Mounts on standard drilling motors including GE752, GEB20, GEB28, GEB29, and Dominator frames
- + Available in stainless and carbon steel

Certifications Available:



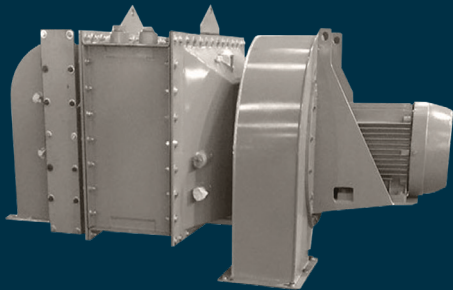

Closed-Loop Cooling Systems

For AC & DC Motors

APPLICATIONS

- + Dirty Environments
- + High Temperatures
- + Marine & Dredging
- + Plastic & Extruding
- + Pulp & Paper
- + Offshore Drilling
- + Tire & Rubber

Our closed-loop cooling system is designed to provide sufficient cooling to most AC and DC motors. This greatly eliminates downtime and expensive alternatives.

MODELS	5 HP	7.5 HP	10 HP	20 HP	25 HP
--------	------	--------	-------	-------	-------

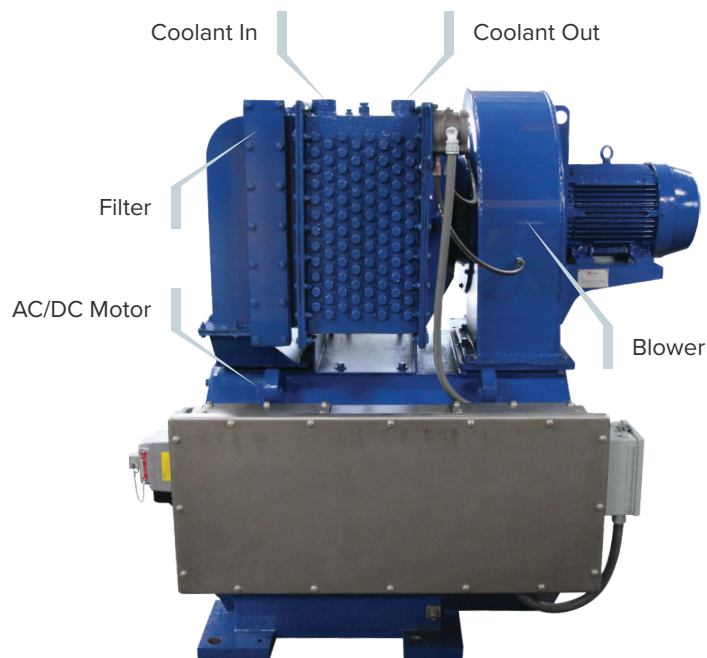

Certifications Available:



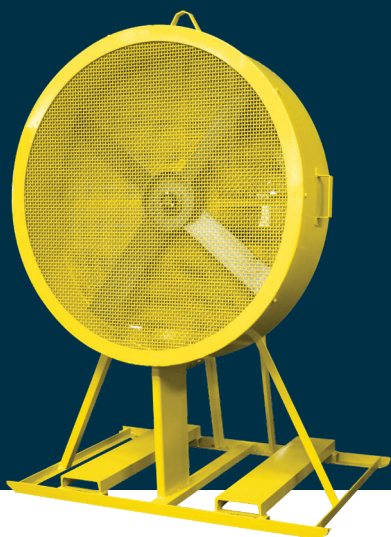

Bug Blowers

Floor, Skid, & Bulkhead Mount

Certifications Available:



SIZE	CFM	HP	RPM	VOLTS	FREQ	WT
24"	6,000	2	1,800	460	60Hz	400 lbs
48"	25,000	3	900	460	60Hz	650 lbs
50"	25,000	5	-	460	60Hz	530 lbs
	38,000	5	1,200	460	60Hz	680 lbs
	40,000	7.5	1,200	460	60Hz	766 lbs

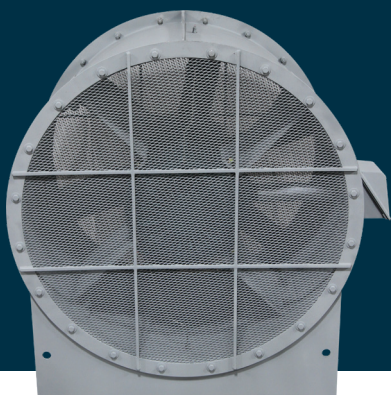

Axial Fans

Floor, Skid, & Bulkhead Mount

SIZE	CFM	FPM	BHP	RPM	MAX RPM
55"	85,000	5,130	53	1,172	1,500

FEATURES

- + Three phase motor
- + Motor in TEFC enclosure
- + Starter in explosion proof enclosure
- + Cast aluminum impeller
- + Carbon steel blowerp
- + 360° horizontal rotation
- + Floor, skid, bulkhead mounted
- + Lifting eye on fan housing
- + Painted safety yellow
- + Power cable not included

Certifications Available:





Single-Phase Motors

TEFC Rolled Steel

Foot Mount / General Purpose Motors

APPLICATIONS

- + General Purpose in Damp & Dusty/Dirty Environments
- + Compressors
- + Fans
- + Material Handling
- + Pumps

FEATURES

- + High Efficient
- + Design B
- + Class F Insulation
- + 40°C Ambient Temperature
- + Double Shielded Bearings
- + Rolled Steel Frame & Aluminum End Shield

HP	RPM	VOLTS	FRAME	MODEL	SF	FL AMPS	FL EFF	WT
1/4	3600	115 / 230	48	RS142T01	1	3.4 / 1.7	61%	17 lbs
	1800	115 / 230	48	RS144T01	1	4.2 / 2.1	65%	19 lbs
1/3	3600	115 / 230	48	RS132T01	1.15	4.2 / 2.1	65%	21 lbs
		115 / 230	56	RS132T02	1.35	5.2 / 2.6	58%	23 lbs
	1800	115 / 230	48	RS134T01	1.15	5.2 / 2.6	68%	23 lbs
		115 / 230	56	RS134T02	1	4.8 / 2.4	65%	22 lbs
1/2	3600	115 / 230	48	RS122T01	1.15	5.8 / 2.9	69%	23 lbs
		115 / 230	56	RS122T02	1.15	6.6 / 3.3	65%	26 lbs
	1800	115 / 230	48	RS124T01	1.15	7.2 / 3.6	71%	26 lbs
		115 / 230	56	RS124T02	1.25	6.4 / 3.2	69%	23 lbs
3/4	3600	115 / 230	56	RS342T01	1.15	8.6 / 4.3	70%	30 lbs
	1800	115 / 230	56	RS344T01	1	8.8 / 4.4	73%	25 lbs
1	3600	115 / 230	56	RS12T01	1.15	10.8 / 5.4	73%	36 lbs
	1800	115 / 230	56	RS14T01	1.15	11.2 / 5.6	75%	40 lbs
1.5	3600	115 / 230	143T	RS322T01	1.15	13.8 / 6.9	74%	45 lbs
	1800	115 / 230	145T	RS324T01	1	13.4 / 6.7	76%	48 lbs
2	3600	115 / 230	56	RS22T01	1.15	18.0 / 9.0	76%	40 lbs
		230	182T	RS22T02	1.15	9	76%	51 lbs
	1800	115 / 230	56	RS24T01	1.15	17.8 / 8.9	77%	75 lbs
		230	182T	RS24T02	1.15	8.9	77%	77 lbs
3	3600	230	182T	RS32T01	1	13.1	78%	81 lbs
	1800	230	182T	RS34T01	1	13	79%	75 lbs
5	3600	230	184T	RS52T01	1	21.3	80%	97 lbs
	1800	230	184T	RS54T01	1	20.8	82%	90 lbs
7.5	3600	230	213T	RS72T01	1	30.9	83%	86 lbs
	1800	230	213T	RS74T01	1	30.5	84%	126 lbs
10	3600	230	215T	RS102T01	1	40.2	85%	130 lbs
	1800	230	215T	RS104T01	1	39.7	86%	135 lbs

Dimensions & Mounting

Page 166



Single-Phase Motors TEFC Rolled Steel

C-Face / General Purpose Motors

APPLICATIONS

- + General Purpose in Damp & Dusty/Dirty Environments
- + Compressors
- + Fans
- + Material Handling
- + Pumps

FEATURES

- + High Efficient
- + Design B
- + Class F Insulation
- + 40°C Ambient Temperature
- + Double Shielded Bearings
- + Rolled Steel Frame & Aluminum End Shield

HP	RPM	VOLTS	FRAME	MODEL		SF	FL AMPS	FL EFF	WT
				FOOTED	FOOTLESS				
1/4	3600	115 / 230	48C	RS142T11	RS142T21	1	3.4 / 1.7	61%	17 lbs
	1800	115 / 230	48C	RS144T11	RS144T21	1	4.2 / 2.1	65%	19 lbs
1/3	3600	115 / 230	48C	RS132T11	RS132T21	1.15	4.2 / 2.1	65%	21 lbs
		115 / 230	56C	RS132T12	RS132T22	1.35	5.2 / 2.6	58%	23 lbs
	1800	115 / 230	48C	RS134T11	RS134T21	1.15	5.2 / 2.6	68%	23 lbs
		115 / 230	56C	RS134T12	RS134T22	1	4.8 / 2.4	65%	22 lbs
1/2	3600	115 / 230	48C	RS122T11	RS122T21	1.15	5.8 / 2.9	69%	23 lbs
		115 / 230	56C	RS122T12	RS122T22	1.15	6.6 / 3.3	65%	26 lbs
	1800	115 / 230	48C	RS124T11	RS124T21	1.15	7.2 / 3.6	71%	26 lbs
		115 / 230	56C	RS124T12	RS124T22	1.25	6.4 / 3.2	69%	23 lbs
3/4	3600	115 / 230	56C	RS342T11	RS342T21	1.15	8.6 / 4.3	70%	30 lbs
	1800	115 / 230	56C	RS344T11	RS344T21	1	8.8 / 4.4	73%	25 lbs
1	3600	115 / 230	56C	RS12T11	RS12T21	1.15	10.8 / 5.4	73%	36 lbs
	1800	115 / 230	56C	RS14T11	RS14T21	1.15	11.2 / 5.6	75%	40 lbs
1.5	3600	115 / 230	143TC	RS322T11	RS322T21	1.15	13.8 / 6.9	74%	45 lbs
	1800	115 / 230	145TC	RS324T11	RS324T21	1	13.4 / 6.7	76%	48 lbs
2	3600	115 / 230	56C	RS22T11	RS22T21	1.15	18.0 / 9.0	76%	40 lbs
		230	145TC	RS22T12	RS22T22	1.15	9	76%	51 lbs
	1800	115 / 230	145TC	RS24T11	RS24T21	1.15	17.8 / 8.9	77%	75 lbs
3	3600	230	182TC	RS32T11	RS32T21	1	13.1	78%	81 lbs
	1800	230	182TC	RS34T11	RS34T21	1	13	79%	75 lbs
5	3600	230	184TC	RS52T11	RS52T21	1	21.3	80%	97 lbs
	1800	230	184TC	RS54T11	RS54T21	1	20.8	82%	90 lbs

Dimensions & Mounting
Page 167



Single-Phase Motors

ODP Rolled Steel

Foot Mount / General Purpose Motors

APPLICATIONS

- + General Purpose where Contaminants are Minimal
- + Compressors
- + Fans
- + Material Handling
- + Pumps

FEATURES

- + High Efficient
- + Design B
- + Class F Insulation
- + 40°C Ambient Temperature
- + Double Shielded Bearings
- + Rolled Steel Frame & Aluminum End Shield

HP	RPM	VOLTS	FRAME	MODEL	SF	FL AMPS	FL EFF	WT
1/4	3600	115 / 230	48	RS142D01	1	3.4 / 1.7	61%	17 lbs
	1800	115 / 230	48	RS144D01	1	4.2 / 2.1	65%	19 lbs
1/3	3600	115 / 230	48	RS132D01	1.15	4.2 / 2.1	65%	21 lbs
		115 / 230	56	RS132D02	1.35	5.2 / 2.6	58%	23 lbs
	1800	115 / 230	48	RS134D01	1.15	5.2 / 2.6	68%	23 lbs
		115 / 230	56	RS134D02	1	4.8 / 2.4	65%	22 lbs
1/2	3600	115 / 230	48	RS122D01	1.15	5.8 / 2.9	69%	23 lbs
		115 / 230	56	RS122D02	1.15	6.6 / 3.3	65%	26 lbs
	1800	115 / 230	48	RS124D01	1.15	7.2 / 3.6	71%	26 lbs
		115 / 230	56	RS124D02	1.25	6.4 / 3.2	69%	23 lbs
3/4	3600	115 / 230	56	RS342D01	1.15	8.6 / 4.3	70%	30 lbs
	1800	115 / 230	56	RS344D01	1	8.8 / 4.4	73%	25 lbs
1	3600	115 / 230	56	RS12D01	1.15	10.8 / 5.4	73%	36 lbs
	1800	115 / 230	56	RS14D01	1.15	11.2 / 5.6	75%	40 lbs
1.5	3600	115 / 230	143T	RS322D01	1.15	13.8 / 6.9	74%	45 lbs
	1800	115 / 230	145T	RS324D01	1	13.4 / 6.7	76%	48 lbs
2	3600	115 / 230	56	RS22D01	1.15	18.0 / 9.0	76%	40 lbs
		230	182T	RS22D02	1.15	9	76%	51 lbs
	1800	115 / 230	56	RS24D01	1.15	17.8 / 8.9	77%	75 lbs
		230	182T	RS24D02	1.15	8.9	77%	77 lbs
3	3600	230	182T	RS32D01	1	13.1	78%	81 lbs
	1800	230	182T	RS34D01	1	13	79%	75 lbs
5	3600	230	184T	RS52D01	1	21.3	80%	97 lbs
	1800	230	184T	RS54D01	1	20.8	82%	90 lbs
7.5	3600	230	213T	RS72D01	1	30.9	83%	86 lbs
	1800	230	213T	RS74D01	1	30.5	84%	126 lbs
10	3600	230	215T	RS102D01	1	40.2	85%	130 lbs
	1800	230	215T	RS104D01	1	39.7	86%	135 lbs

Dimensions & Mounting

Page 168

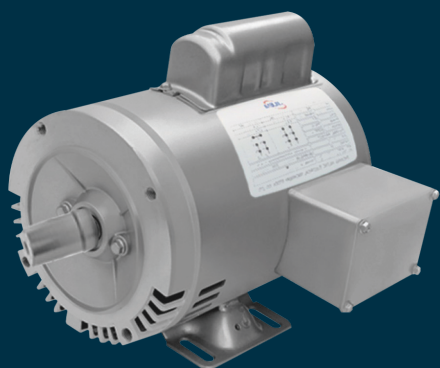

Single-Phase Motors ODP Rolled Steel

C-Face / General Purpose Motors

APPLICATIONS

- + General Purpose where Contaminants are Minimal
- + Compressors
- + Fans
- + Material Handling
- + Pumps

FEATURES

- + High Efficient
- + Design B
- + Class F Insulation
- + 40°C Ambient Temperature
- + Double Shielded Bearings
- + Rolled Steel Frame & Aluminum End Shield

HP	RPM	VOLTS	FRAME	MODEL		SF	FL AMPS	FL EFF	WT
				FOOTED	FOOTLESS				
1/4	3600	115 / 230	48C	RS142D11	RS142D21	1.35	3.8 / 1.9	58%	17 lbs
	1800	115 / 230	48C	RS144D11	RS144D21	1.35	4.6 / 2.3	61%	19 lbs
1/3	3600	115 / 230	48C	RS132D11	RS132D21	1.35	4.8 / 2.4	62%	21 lbs
		115 / 230	56C	RS132D12	RS132D22	1.35	5.2 / 2.6	58%	23 lbs
	1800	115 / 230	48C	RS134D11	RS134D21	1.35	5.4 / 2.7	65%	23 lbs
		115 / 230	56C	RS134D12	RS134D22	1.35	4.8 / 2.4	65%	22 lbs
1/2	3600	115 / 230	48C	RS122D11	RS122D21	1.25	6.2 / 3.1	68%	23 lbs
		115 / 230	56C	RS122D12	RS122D22	1.25	6.6 / 3.3	65%	26 lbs
	1800	115 / 230	48C	RS124D11	RS124D21	1.25	7.6 / 3.8	69%	26 lbs
		115 / 230	56C	RS124D12	RS124D21	1.25	6.4 / 3.2	69%	23 lbs
3/4	3600	115 / 230	56C	RS342D11	RS342D21	1.25	8.6 / 4.3	70%	30 lbs
	1800	115 / 230	56C	RS344D11	RS342D21	1.25	8.8 / 4.4	73%	25 lbs
1	3600	115 / 230	56C	RS12D11	RS12D21	1.25	10.8 / 5.4	73%	36 lbs
	1800	115 / 230	56C	RS14D11	RS14D21	1.15	11.2 / 5.6	75%	40 lbs
1.5	3600	115 / 230	143TC	RS322D11	RS322D21	1.15	13.8 / 6.9	74%	45 lbs
	1800	115 / 230	145TC	RS324D11	RS344D21	1.15	13.4 / 6.7	76%	48 lbs
2	3600	115 / 230	145TC	RS22D11	RS22D21	1.15	18.0 / 9.0	76%	40 lbs
	1800	115 / 230	145TC	RS24D11	RS24D21	1.15	17.8 / 8.9	77%	75 lbs
		3600	230	182TC	RS32D11	RS32D21	1.15	13.1	78%
3	1800	230	182TC	RS34D11	RS34D21	1.15	13	79%	78 lbs
	3600	230	184TC	RS52D11	RS52D21	1.15	21.3	80%	97 lbs
5	1800	230	184TC	RS54D11	RS54D21	1.15	20.8	82%	90 lbs



Three-Phase Motors

TEFC Rolled Steel

Foot Mount / General Purpose Motors

APPLICATIONS

- + General Purpose in Damp & Dusty/Dirty Environments
- + Compressors
- + Fans
- + Material Handling
- + Pumps

FEATURES

- + High Efficient
- + Design B
- + Class F Insulation
- + 40°C Ambient Temperature
- + Double Shielded Bearings
- + Rolled Steel Frame & Aluminum End Shield

HP	RPM	VOLTS	FRAME	MODEL	SF	FL AMPS	FL EFF	WT
1/4	3600	230 / 460	48	RT142T01	1	1.11 / 0.55	68%	17 lbs
	1800	230 / 460	48	RT144T01	1	1.25 / 0.63	60.2%	19 lbs
1/3	3600	230 / 460	48	RT132T01	1	1.15 / 0.57	72%	21 lbs
		230 / 460	56	RT132T02	1	1.16 / 0.58	72%	23 lbs
	1800	230 / 460	48	RT134T01	1	1.32 / 0.66	67%	23 lbs
		230 / 460	56	RT134T02	1	1.38 / 0.69	67%	22 lbs
1/2	3600	230 / 460	48	RT122T01	1	1.57 / 0.78	74%	23 lbs
		230 / 460	56	RT122T02	1	1.65 / 0.83	74%	26 lbs
	1800	230 / 460	48	RT124T01	1	1.7 / 0.85	70%	26 lbs
		230 / 460	56	RT124T02	1	1.84 / 0.92	70%	23 lbs
3/4	3600	230 / 460	56	RT342T01	1	2.34 / 1.17	76%	30 lbs
	1800	230 / 460	56	RT344T01	1	2.57 / 1.28	74%	25 lbs
1	3600	230 / 460	143T	RT12T01	1.25	3.13 / 1.57	77%	39 lbs
	1800	230 / 460	56	RT14T01	1.25	2.98 / 1.49	85.5%	42 lbs
1.5	3600	230 / 460	143T	RT322T01	1.25	3.96 / 1.98	84%	51 lbs
	1800	230 / 460	143T	RT324T01	1.25	4.2 / 2.1	86.5%	50 lbs
2	3600	230 / 460	145T	RT22T01	1.25	5.31 / 2.65	85.5%	55 lbs
		230 / 460	56	RT24T01	1.25	5.65 / 2.83	86.5%	52 lbs
	1800	230 / 460	145T	RT24T02	1.25	5.51 / 2.76	86.5%	53 lbs
3	3600	230 / 460	145T	RT32T01	1.25	7.71 / 3.59	86.5%	83 lbs
	1800	230 / 460	182T	RT34T01	1.25	7.81 / 3.91	89.5%	76 lbs
5	3600	230 / 460	184T	RT52T01	1.25	11.5 / 5.77	88.5%	98 lbs
	1800	230 / 460	184T	RT54T01	1.25	13.1 / 6.57	89.5%	92 lbs
7.5	3600	230 / 460	184T	RT72T01	1.25	17.5 / 8.76	89.5%	87 lbs
	1800	230 / 460	213T	RT74T01	1.25	18.1 / 9.17	91.7%	128 lbs
10	3600	230 / 460	215T	RT102T01	1.25	23.7 / 11.9	90.2%	123 lbs
	1800	230 / 460	215T	RT104T01	1.25	24.7 / 12.4	91.7%	136 lbs

Dimensions & Mounting

Page 170



Three-Phase Motors TEFC Rolled Steel

C-Face / General Purpose Motors

APPLICATIONS

- + General Purpose in Damp & Dusty/Dirty Environments
- + Compressors
- + Fans
- + Material Handling
- + Pumps

FEATURES

- + High Efficient
- + Design B
- + Class F Insulation
- + 40°C Ambient Temperature
- + Double Shielded Bearings
- + Rolled Steel Frame & Aluminum End Shield

HP	RPM	VOLTS	FRAME	MODEL		SF	FL AMPS	FL EFF	WT
				FOOTED	FOOTLESS				
1/4	3600	230 / 460	48C	RT142T11	RT142T21	1	1.11 / 0.55	68%	17 lbs
	1800	230 / 460	48C	RT144T11	RT144T21	1	1.25 / 0.63	60.2%	19 lbs
1/3	3600	230 / 460	48C	RT132T11	RT132T21	1	1.15 / 0.57	72%	21 lbs
		230 / 460	56C	RT132T12	RT132T22	1	1.16 / 0.58	72%	23 lbs
	1800	230 / 460	48C	RT134T11	RT134T21	1	1.32 / 0.66	67%	23 lbs
		230 / 460	56C	RT134T12	RT134T22	1	1.38 / 0.69	67%	22 lbs
1/2	3600	230 / 460	48C	RT122T11	RT122T21	1	1.57 / 0.78	74%	23 lbs
		230 / 460	56C	RT122T12	RT122T22	1	1.65 / 0.83	74%	26 lbs
	1800	230 / 460	48C	RT124T11	RT124T21	1	1.7 / 0.85	70%	26 lbs
		230 / 460	56C	RT124T12	RT124T22	1	1.84 / 0.92	70%	23 lbs
3/4	3600	230 / 460	56C	RT342T11	RT342T21	1	2.34 / 1.17	76%	30 lbs
	1800	230 / 460	56C	RT344T11	RT344T21	1	2.57 / 1.28	74%	25 lbs
1	3600	230 / 460	143TC	RT12T11	RT12T21	1.25	3.13 / 1.57	77%	39 lbs
	1800	230 / 460	56C	RT14T11	RT14T21	1.25	2.98 / 1.49	85.5%	42 lbs
1.5	3600	230 / 460	143TC	RT322T11	RT322T21	1.25	3.96 / 1.98	84%	51 lbs
	1800	230 / 460	143TC	RT324T11	RT324T21	1.25	4.2 / 2.1	86.5%	50 lbs
2	3600	230 / 460	145TC	RT22T11	RT22T21	1.25	5.31 / 2.65	85.5%	55 lbs
		230 / 460	56C	RT24T11	RT24T21	1.25	5.65 / 2.83	86.5%	52 lbs
	1800	230 / 460	145TC	RT24T12	RT24T22	1.25	5.51 / 2.76	86.5%	53 lbs
3	3600	230 / 460	145TC	RT32T11	RT32T21	1.25	7.71 / 3.59	86.5%	83 lbs
	1800	230 / 460	182TC	RT34T11	RT34T21	1.25	7.81 / 3.91	89.5%	76 lbs
5	3600	230 / 460	184TC	RT52T11	RT52T21	1.25	11.5 / 5.77	88.5%	98 lbs
	1800	230 / 460	184TC	RT54T11	RT54T21	1.25	13.1 / 6.57	89.5%	92 lbs
7.5	3600	230 / 460	184TC	RT72T11	RT72T21	1.25	17.5 / 8.76	89.5%	87 lbs
	1800	230 / 460	213TC	RT74T11	RT74T21	1.25	18.1 / 9.17	91.7%	128 lbs
10	3600	230 / 460	215TC	RT102T11	RT102T21	1.25	23.7 / 11.9	90.2%	123 lbs
	1800	230 / 460	215TC	RT104T11	RT104T21	1.25	24.7 / 12.4	91.7%	136 lbs

Dimensions & Mounting
Page 171



Three-Phase Motors

ODP Rolled Steel

Foot Mount / General Purpose Motors

APPLICATIONS

- + General Purpose where Contaminants are Minimal
- + Compressors
- + Fans
- + Material Handling
- + Pumps

FEATURES

- + High Efficient
- + Design B
- + Class F Insulation
- + 40°C Ambient Temperature
- + Double Shielded Bearings
- + Rolled Steel Frame & Aluminum End Shield

HP	RPM	VOLTS	FRAME	MODEL	SF	FL AMPS	FL EFF	WT
1/4	3600	230 / 460	48	RT142D01	1.35	1.11 / 0.55	68.1%	17 lbs
	1800	230 / 460	48	RT144D01	1.35	1.25 / 0.63	60.2%	19 lbs
1/3	3600	230 / 460	48	RT132D01	1.35	1.15 / 0.57	72%	21 lbs
		230 / 460	56	RT132D02	1.35	1.16 / 0.58	72%	23 lbs
	1800	230 / 460	48	RT134D01	1.35	1.32 / 0.66	67%	23 lbs
		230 / 460	56	RT134D02	1.25	1.38 / 0.69	67%	22 lbs
1/2	3600	230 / 460	48	RT142D01	1.25	1.53 / 0.76	74%	23 lbs
		230 / 460	56	RT142D02	1.25	1.61 / 0.83	74%	26 lbs
	1800	230 / 460	48	RT144D01	1.25	1.7 / 0.85	70%	26 lbs
		230 / 460	56	RT144D02	1.25	1.84 / 0.92	70%	23 lbs
3/4	3600	230 / 460	48	RT342D01	1.25	2.34 / 1.17	76%	30 lbs
	1800	230 / 460	56	RT344D01	1.25	2.57 / 1.28	74%	25 lbs
1	3600	230 / 460	143T	RT12D01	1.15	3.13 / 1.57	77%	39 lbs
	1800	230 / 460	56H	RT14D01	1.15	2.89 / 1.49	85.5%	42 lbs
1.5	3600	230 / 460	143T	RT322D01	1.15	3.96 / 1.98	84%	52 lbs
	1800	230 / 460	56H	RT324D01	1.15	4.2 / 2.1	86.5%	50 lbs
2	3600	230 / 460	145T	RT222D01	1.15	5.31 / 2.65	85.5%	54 lbs
		230 / 460	145T	RT224D01	1.15	5.65 / 2.83	86.5%	52 lbs
	1800	230 / 460	56HZ	RT224D02	1.15	5.51 / 2.76	86.5%	53 lbs
3	3600	230 / 460	182T	RT32D01	1.15	7.26 / 3.63	85.5%	82 lbs
	1800	230 / 460	182T	RT34D01	1.15	7.81 / 3.91	89.5%	76 lbs
5	3600	230 / 460	182T	RT52D01	1.15	11.8 / 5.9	86.5%	98 lbs
	1800	230 / 460	184T	RT54D01	1.15	13.1 / 6.57	89.5%	92 lbs
7.5	3600	230 / 460	184T	RT72D01	1.15	17.7 / 8.86	88.5%	88 lbs
	1800	230 / 460	213T	RT74D01	1.15	18.3 / 9.14	91%	127 lbs
10	3600	230 / 460	213T	RT102D01	1.15	23.9 / 12	89.5%	122 lbs
	1800	230 / 460	215T	RT104D01	1.15	24.7 / 12.4	91.7%	136 lbs

Dimensions & Mounting

Page 172



Three-Phase Motors

ODP Rolled Steel

C-Face / General Purpose Motors

APPLICATIONS

- + General Purpose where Contaminants are Minimal
- + Compressors
- + Fans
- + Material Handling
- + Pumps

FEATURES

- + High Efficient
- + Design B
- + Class F Insulation
- + 40°C Ambient Temperature
- + Double Shielded Bearings
- + Rolled Steel Frame & Aluminum End Shield

HP	RPM	VOLTS	FRAME	MODEL		SF	FL AMPS	FL EFF	WT
				FOOTED	FOOTLESS				
1/4	3600	230 / 460	48C	RT142D11	RT142D21	1.35	1.11 / 0.55	68.1%	17 lbs
	1800	230 / 460	48C	RT144D11	RT144D21	1.35	1.25 / 0.63	60.2%	19 lbs
1/3	3600	230 / 460	48C	RT132D11	RT132D21	1.35	1.15 / 0.57	72%	21 lbs
		230 / 460	56C	RT132D12	RT132D22	1.35	1.16 / 0.58	72%	23 lbs
	1800	230 / 460	48C	RT134D11	RT134D21	1.35	1.32 / 0.66	67%	23 lbs
		230 / 460	56C	RT134D12	RT134D22	1.25	1.38 / 0.69	67%	22 lbs
1/2	3600	230 / 460	48C	RT142D11	RT142D21	1.25	1.53 / 0.76	74%	23 lbs
		230 / 460	56C	RT142D12	RT142D22	1.25	1.61 / 0.83	74%	26 lbs
	1800	230 / 460	48C	RT144D11	RT144D21	1.25	1.7 / 0.85	70%	26 lbs
		230 / 460	56C	RT144D12	RT144D22	1.25	1.84 / 0.92	70%	23 lbs
3/4	3600	230 / 460	48C	RT342D11	RT342D21	1.25	2.34 / 1.17	76%	30 lbs
	1800	230 / 460	56C	RT344D11	RT344D21	1.25	2.57 / 1.28	74%	25 lbs
1	3600	230 / 460	143TC	RT12D11	RT12D21	1.15	3.13 / 1.57	77%	39 lbs
	1800	230 / 460	56HC	RT14D11	RT14D21	1.15	2.89 / 1.49	85.5%	42 lbs
1.5	3600	230 / 460	143TC	RT322D11	RT322D21	1.15	3.96 / 1.98	84%	52 lbs
	1800	230 / 460	56HC	RT324D11	RT324D21	1.15	4.2 / 2.1	86.5%	50 lbs
2	3600	230 / 460	145TC	RT222D11	RT222D21	1.15	5.31 / 2.65	85.5%	54 lbs
		230 / 460	145TC	RT224D11	RT224D21	1.15	5.65 / 2.83	86.5%	52 lbs
	1800	230 / 460	56HZC	RT224D12	RT224D22	1.15	5.51 / 2.76	86.5%	53 lbs
3	3600	230 / 460	182TC	RT32D11	RT32D21	1.15	7.26 / 3.63	85.5%	82 lbs
	1800	230 / 460	182TC	RT34D11	RT34D21	1.15	7.81 / 3.91	89.5%	76 lbs
5	3600	230 / 460	182TC	RT52D11	RT52D21	1.15	11.8 / 5.9	86.5%	98 lbs
	1800	230 / 460	184TC	RT54D11	RT54D21	1.15	13.1 / 6.57	89.5%	92 lbs
7.5	3600	230 / 460	184TC	RT72D11	RT72D21	1.15	17.7 / 8.86	88.5%	88 lbs
	1800	230 / 460	213TC	RT74D11	RT74D21	1.15	18.3 / 9.14	91%	127 lbs
10	3600	230 / 460	213TC	RT102D11	RT102D21	1.15	23.9 / 12	89.5%	122 lbs
	1800	230 / 460	215TC	RT104D11	RT104D21	1.15	24.7 / 12.4	91.7%	136 lbs

Dimensions & Mounting
Page 173



EISA High Efficient Motors TEFC Cast Iron

Foot Mount / General Purpose Motors

APPLICATIONS

- + General Purpose in Damp & Dusty/Dirty Environments
- + Process Industries
- + Blowers
- + Compressors
- + Conveyors
- + Fans
- + Pumps

FEATURES

- + EISA Compliant High Efficient
- + Service Factor 1.15
- + Design C High Torque
- + Class F Insulation
- + 40°C Ambient Temperature
- + Cast Iron Frame & End Shield

HP	RPM	VOLTS	FRAME	MODEL	FL AMPS	FL EFF	WT
1	3600	208-230 / 460	56	HE12T01	1.44	81%	44 lbs
	1800	208-230 / 460	56	HE14T01	1.47	80%	46 lbs
		208-230 / 460	143T	HE14T02	1.49	82.5%	47 lbs
	1200	208-230 / 460	56	HE16T01	1.92	76.7%	46 lbs
208-230 / 460		145T	HE16T02	1.7	80%	47 lbs	
1.5	3600	208-230 / 460	56	HE322T01	1.97	82.5%	48 lbs
		208-230 / 460	143T	HE322T02	1.99	82.5%	45 lbs
	1800	208-230 / 460	56	HE324T01	2.11	81%	52 lbs
		208-230 / 460	145T	HE324T02	2.05	84%	54 lbs
1200	208-230 / 460	182T	HE326T01	2.38	85.5%	77 lbs	
	2	3600	208-230 / 460	56	HE22T01	2.67	84%
208-230 / 460			145T	HE22T02	2.6	84%	47 lbs
1800		208-230 / 460	56	HE24T01	2.84	82%	61 lbs
		208-230 / 460	145T	HE24T02	2.7	84%	56 lbs
1200	208-230 / 460	184T	HE26T01	3.2	86.5%	88 lbs	
	3	3600	208-230 / 460	56	HE32T01	3.8	84.5%
208-230 / 460			182T	HE32T02	3.59	85.5%	106 lbs
1800		208-230 / 460	182T	HE34T01	3.9	87.5%	97 lbs
		208-230 / 460	213T	HE36T01	4.15	87.5%	123 lbs
5	3600	208-230 / 460	184T	HE52T01	5.9	87.5%	114 lbs
	1800	208-230 / 460	184T	HE54T01	6.48	87.5%	102 lbs
		208-230 / 460	215T	HE56T01	6.8	87.5%	175 lbs
7.5	3600	208-230 / 460	213T	HE72T01	8.66	88.5%	150 lbs
	1800	208-230 / 460	213T	HE74T01	9.53	89.5%	150 lbs
		208-230 / 460	254T	HE76T01	9.53	89.5%	262 lbs
10	3600	208-230 / 460	215T	HE102T01	11.7	89.5%	150 lbs
	1800	208-230 / 460	215T	HE104T01	12.8	90.2%	165 lbs
		208-230 / 460	256T	HE106T01	13.4	89.5%	304 lbs
15	3600	208-230 / 460	254T	HE152T01	17	90.2%	280 lbs
	1800	208-230 / 460	254T	HE154T01	17.9	91%	266 lbs
		208-230 / 460	284T	HE156T01	17.3	91%	346 lbs
20	3600	208-230 / 460	256T	HE202T01	23.3	90.2%	313 lbs
	1800	208-230 / 460	256T	HE204T01	24.4	91%	313 lbs
		208-230 / 460	286T	HE206T01	23.5	91%	470 lbs

(Continued)

HP	RPM	VOLTS	FRAME	MODEL	FL AMPS	FL EFF	WT
25	3600	208-230 / 460	284TS	HE252T01	29	91%	353 lbs
	1800	208-230 / 460	284TS	HE254T01	29.6	92.4%	437 lbs
		208-230 / 460	284T	HE254T02	29.6	92.4%	437 lbs
	1200	208-230 / 460	324T	HE256T01	29.8	91.7%	572 lbs
30	3600	208-230 / 460	286TS	HE302T01	33.8	91%	404 lbs
	1800	208-230 / 460	286TS	HE304T01	34.4	92.4%	481 lbs
		208-230 / 460	286T	HE304T02	34.4	92.4%	481 lbs
	1200	208-230 / 460	326T	HE306T01	35.4	91.7%	625 lbs
40	3600	208-230 / 460	324TS	HE402T01	46.1	91.7%	561 lbs
	1800	208-230 / 460	324TS	HE404T01	47.6	93%	587 lbs
		208-230 / 460	324T	HE404T02	47.6	93%	587 lbs
	1200	208-230 / 460	364T	HE406T01	47.1	93%	992 lbs
50	3600	208-230 / 460	326TS	HE502T01	56.5	92.4%	594 lbs
	1800	208-230 / 460	326TS	HE504T01	57.8	93.6%	640 lbs
		208-230 / 460	326T	HE504T02	57.8	93.6%	640 lbs
	1200	208-230 / 460	365T	HE506T01	58.1	93%	992 lbs
60	3600	208-230 / 460	364TS	HE602T01	69	93%	917 lbs
	1800	208-230 / 460	364TS	HE604T01	67	93.6%	963 lbs
		208-230 / 460	364T	HE604T02	67	93.6%	963 lbs
	1200	208-230 / 460	404T	HE606T01	70.1	93.6%	1222 lbs
75	3600	208-230 / 460	365TS	HE752T01	82.5	93%	1025 lbs
	1800	208-230 / 460	365TS	HE754T01	82.4	94.1%	1010 lbs
		208-230 / 460	365T	HE754T02	82.4	94.1%	1010 lbs
	1200	208-230 / 460	405T	HE756T01	86.8	93.6%	1291 lbs
100	3600	208-230 / 460	405TS	HE1002T01	113	93.6%	1361 lbs
	1800	208-230 / 460	405TS	HE1004T01	115	94.5%	1273 lbs
		208-230 / 460	405T	HE1004T02	115	94.5%	1273 lbs
	1200	208-230 / 460	444T	HE1006T01	121	94.1%	1720 lbs
125	3600	460	444TS	HE1252T01	131	94.5%	1801 lbs
	1800	460	444TS	HE1254T01	138	94.5%	1647 lbs
		460	444T	HE1254T02	138	94.5%	1647 lbs
	1200	460	445T	HE1256T01	141	94.1%	2050 lbs
150	3600	460	445TS	HE1502T01	160	94.5%	1865 lbs
	1800	460	445TS	HE1504T01	168	95%	1841 lbs
		460	445T	HE1504T02	168	95%	1841 lbs
	1200	460	447T	HE1506T01	171	95%	2167 lbs
200	3600	460	447TS	HE2002T01	223	95%	2072 lbs
	1800	460	445T	HE2004T01	230	95%	2117 lbs
		460	447T	HE2004T02	230	95%	2194 lbs
	1200	460	447T	HE2006T01	236	95%	2467 lbs

CONTROLS

ENERGY STORAGE

MOTORS

PUMPS

VALVES

COMPRESSORS

PNEUMATICS

SAWMILLS

METAL RECYCLING

TRANSIT & RAILROAD

WATER & WASTEWATER

DIMENSIONS & MOUNTING



EISA High Efficient Motors TEFC Cast Iron

C-Face / General Purpose Motors

FEATURES

- + EISA Compliant High Efficient
- + Service Factor 1.15
- + Design C High Torque
- + Class F Insulation
- + 40°C Ambient Temperature
- + Cast Iron Frame & End Shield

APPLICATIONS

- + General Purpose in Damp & Dusty/Dirty Environments
- + Process Industries
- + Blowers
- + Compressors
- + Conveyors
- + Fans
- + Pumps

HP	RPM	VOLTS	FRAME	MODEL		FL AMPS	FL EFF	WT
				FOOTED	FOOTLESS			
1	3600	208-230 / 460	56C	HE12T11	HE12T21	1.44	81%	44 lbs
			56C	HE14T11	HE14T21	1.47	80%	46 lbs
	1800	208-230 / 460	143TC	HE14T12	HE14T22	1.49	82.5%	47 lbs
			56C	HE16T11	HE16T21	1.92	76.7%	46 lbs
1.5	3600	208-230 / 460	56C	HE322T11	HE322T21	1.97	82.5%	48 lbs
			143TC	HE322T12	HE322T22	1.99	82.5%	45 lbs
	1800	208-230 / 460	56C	HE324T11	HE324T21	2.11	81%	52 lbs
			145TC	HE324T12	HE324T22	2.05	84%	54 lbs
2	3600	208-230 / 460	56C	HE22T11	HE22T21	2.67	84%	58 lbs
			145TC	HE22T12	HE22T22	2.6	84%	47 lbs
	1800	208-230 / 460	56C	HE24T11	HE24T21	2.84	82%	61 lbs
			145TC	HE24T12	HE24T22	2.7	84%	56 lbs
3	3600	208-230 / 460	56C	HE32T11	HE32T21	3.8	84.5%	67 lbs
			182TC	HE32T12	HE32T22	3.59	85.5%	106 lbs
	1800	208-230 / 460	182TC	HE34T11	HE34T21	3.9	87.5%	97 lbs
			213TC	HE36T11	HE36T21	4.15	87.5%	123 lbs
5	3600	208-230 / 460	184TC	HE52T11	HE52T21	5.9	87.5%	114 lbs
	1800	208-230 / 460	184TC	HE54T11	HE54T21	6.48	87.5%	102 lbs
	1200	208-230 / 460	215TC	HE56T11	HE56T21	6.8	87.5%	175 lbs
7.5	3600	208-230 / 460	213TC	HE72T11	HE72T21	8.66	88.5%	150 lbs
	1800	208-230 / 460	213TC	HE74T11	HE74T21	9.53	89.5%	150 lbs
	1200	208-230 / 460	254TC	HE76T11	HE76T21	9.53	89.5%	262 lbs
10	3600	208-230 / 460	215TC	HE102T11	HE102T21	11.7	89.5%	150 lbs
	1800	208-230 / 460	215TC	HE104T11	HE104T21	12.8	90.2%	165 lbs
	1200	208-230 / 460	256TC	HE106T11	HE106T21	13.4	89.5%	304 lbs
15	3600	208-230 / 460	254TC	HE152T11	HE152T21	17	90.2%	280 lbs
	1800	208-230 / 460	254TC	HE154T11	HE154T21	17.9	91%	266 lbs

(Continued)

HP	RPM	VOLTS	FRAME	MODEL		FL AMPS	FL EFF	WT
				FOOTED	FOOTLESS			
20	3600	208-230 / 460	256TC	HE202T11	HE202T21	23.3	90.2%	313 lbs
	1800	208-230 / 460	256TC	HE204T11	HE204T21	24.4	91%	313 lbs
25	3600	208-230 / 460	284TSC	HE252T11	HE252T21	29	91%	353 lbs
	1800	208-230 / 460	284TSC	HE254T11	HE254T21	29.6	92.4%	437 lbs
	1800	208-230 / 460	284TC	HE254T12	HE254T22	29.6	92.4%	437 lbs
30	3600	208-230 / 460	286TSC	HE302T11	HE302T21	33.8	91%	404 lbs
	1800	208-230 / 460	286TSC	HE304T11	HE304T21	34.4	92.4%	481 lbs
	1800	208-230 / 460	286TC	HE304T12	HE304T22	34.4	92.4%	481 lbs
40	1800	208-230 / 460	324TSC	HE404T11	-	47.6	93%	587 lbs
	1800	208-230 / 460	324TC	HE404T12	-	47.6	93%	587 lbs
50	1800	208-230 / 460	326TSC	HE504T11	-	57.8	93.6%	640 lbs
	1800	208-230 / 460	326TC	HE504T12	-	57.8	93.6%	640 lbs
60	1800	208-230 / 460	364TSC	HE604T11	-	67	93.6%	963 lbs
	1800	208-230 / 460	364TC	HE604T12	-	67	93.6%	963 lbs
75	1800	208-230 / 460	365TSC	HE754T11	-	82.4	94.1%	1010 lbs
	1800	208-230 / 460	365TC	HE754T12	-	82.4	94.1%	1010 lbs
	1800	460	365TC	HE754T13	-	82.4	94.1%	1010 lbs
100	1800	208-230 / 460	405TSC	HE1004T11	-	115	94.5%	1273 lbs
	1800	460	405TSC	HE1004T12	-	115	94.5%	1273 lbs
	1800	208-230 / 460	405TC	HE1004T13	-	115	94.5%	1273 lbs
	1800	460	405TC	HE1004T14	-	115	94.5%	1273 lbs
125	1800	460	444TC	HE1254T11	-	138	94.5%	1647 lbs
150	1800	460	445TC	HE1504T11	-	168	95%	1841 lbs
200	1800	460	445TC	HE2004T11	-	230	95%	2194 lbs

CONTROLS

ENERGY STORAGE

MOTORS

PUMPS

VALVES

COMPRESSORS

PNEUMATICS

SAWMILLS

METAL RECYCLING

TRANSIT & RAILROAD

WATER & WASTEWATER

DIMENSIONS & MOUNTING



EISA High Efficient Motors

TEFC Aluminum

Foot Mount / General Purpose Motors

FEATURES

- + EISA Compliant High Efficient
- + Low Noise
- + Service Factor 1.15
- + Design C High Torque
- + Class F Insulation
- + 40°C Ambient Temperature
- + Aluminum Frame & End Shield
(D Flange Available)
- + Removable Base

APPLICATIONS

- + General Purpose
- + Blowers
- + Compressors
- + Conveyors
- + Fans
- + Pumps
- + Reducers

HP	RPM	VOLTS	FRAME	MODEL	FL AMPS	FL EFF	WT
1/4	3260	208-230 / 460	48	AE142T01	0.96-0.9 / 0.43	65%	17 lbs
	1570	208-230 / 460	48	AE144T01	1.14-1 / 0.52	60%	18 lbs
	1020	208-230 / 460	56	AE146T01	1.35-1.2 / 0.61	56%	23 lbs
1/3	3260	208-230 / 460	48	AE132T01	1.26-1.1 / 0.57	68%	18 lbs
	1595	208-230 / 460	48	AE132T01	1.44-1.3 / 0.65	65%	19 lbs
1/2	3285	208-230 / 460	48	AE122T01	1.81-1.6 / 0.82	70%	19 lbs
	1595	208-230 / 460	56	AE124T01	2.04-1.8 / 0.92	67%	26 lbs
	1060	208-230 / 460	56	AE126T01	2.37-2.1 / 1.07	62%	24 lbs
3/4	3285	208-230 / 460	48	AE342T01	2.55-2.3 / 1.15	73%	20 lbs
	1665	208-230 / 460	56	AE344T01	2.86-2.6 / 1.29	71.1%	28 lbs
	1060	208-230 / 460	143T	AE346T01	3.26-3 / 1.48	65%	27 lbs
1	3405	208-230 / 460	56	AE12T01	3.34-3 / 1.51	75.1%	26 lbs
	1665	208-230 / 460	143T	AE14T01	3.75-3.4 / 1.69	73.1%	29 lbs
	1090	208-230 / 460	145T	AE16T01	4.19-3.8 / 1.89	69%	29 lbs
	815	208-230 / 460	182T	AE18T01	4.38-4 / 1.98	71%	57 lbs
1.5	3405	208-230 / 460	143T	AE322T01	4.72-4.3 / 2.13	77%	28 lbs
	1665	208-230 / 460	145T	AE324T01	5.2-4.7 / 2.35	76.3%	30 lbs
	1090	208-230 / 460	182T	AE326T01	5.8-5.2 / 2.62	72.1%	57 lbs
	815	208-230 / 460	184T	AE328T01	6.06-5.5 / 2.74	73%	62 lbs
2	3405	208-230 / 460	145T	AE22T01	6.27-5.7 / 2.84	79%	30 lbs
	1665	208-230 / 460	145T	AE24T01	6.71-6.1 / 3.03	78.6%	31 lbs
	1100	208-230 / 460	184T	AE26T01	7.29-6.6 / 3.3	76.1%	64 lbs
	825	208-230 / 460	213T	AE28T01	8.05-7.3 / 3.64	75%	84 lbs
3	3405	208-230 / 460	145T	AE32T01	8.86-8 / 4.01	81.1%	33 lbs
	1690	208-230 / 460	182T	AE34T01	9.28-8.4 / 4.2	81.2%	62 lbs
	1150	208-230 / 460	213T	AE36T01	9.91-9 / 4.48	81.1%	84 lbs
	845	208-230 / 460	215T	AE38T01	11-10 / 4.99	78%	93 lbs
5	3455	208-230 / 460	184T	AE52T01	13.8-13 / 6.25	84.4%	62 lbs
	1720	208-230 / 460	184T	AE54T01	14.7-13 / 6.72	84.3%	66 lbs
	1150	208-230 / 460	215T	AE56T01	16.5-15 / 7.44	82.1%	97 lbs
	860	208-230 / 460	254T	AE58T01	17.4-16 / 7.85	81%	152 lbs

Dimensions & Mounting

Page 180

(Continued)

HP	RPM	VOLTS	FRAME	MODEL	FL AMPS	FL EFF	WT
7.5	3480	208-230 / 460	184T	AE72T01	20.2-18 / 9.13	85.9%	86 lbs
	1725	208-230 / 460	213T	AE74T01	21.4-19 / 9.69	85.8%	93 lbs
	1150	208-230 / 460	254T	AE76T01	23.6-21 / 10.7	84.1%	150 lbs
	860	208-230 / 460	256T	AE78T01	24.9-22 / 11.2	83%	192 lbs
10	3480	208-230 / 460	215T	AE102T01	27.1-25 / 12.3	87.2%	110 lbs
	1725	208-230 / 460	215T	AE104T01	28.5-26 / 12.9	87.1%	107 lbs
	1150	208-230 / 460	256T	AE106T01	31.4-28 / 14.2	86.1%	161 lbs
15	3515	208-230 / 460	254T	AE152T01	38.8-35 / 17.5	88.5%	150 lbs
	1750	208-230 / 460	254T	AE154T01	41.1-37 / 18.6	88.5%	163 lbs
20	3515	208-230 / 460	256T	AE202T01	52.3-47 / 23.6	89.5%	181 lbs
	1750	208-230 / 460	256T	AE204T01	54.7-49 / 24.7	89.5%	191 lbs
25	3515	208-230 / 460	284T	AE252T01	63.3-57 / 28.6	90.2%	225 lbs
	1760	208-230 / 460	284T	AE254T01	66.3-60 / 30	90.1%	223 lbs
30	3525	208-230 / 460	286T	AE302T01	74.8-68 / 33.8	90.7%	265 lbs
	1760	208-230 / 460	286T	AE304T01	78.4-71 / 35.4	90.6%	247 lbs

CONTROLS

ENERGY STORAGE

MOTORS

PUMPS

VALVES

COMPRESSORS

PNEUMATICS

SAWMILLS

METAL RECYCLING

TRANSIT & RAILROAD

WATER & WASTEWATER

DIMENSIONS & MOUNTING

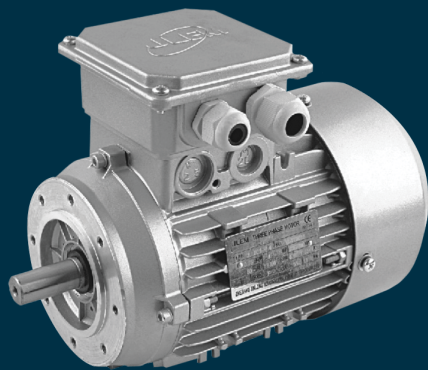

EISA High Efficient Motors TEFC Aluminum

C-Face / General Purpose Motors

FEATURES

- + Class F Insulation
- + Design B
- + Rolled Steel Frame
- + Aluminum End Shields
- + Double Shielded Bearings
- + 40°C Ambient
- + High Efficient

APPLICATIONS

- + General Purpose
- + Blowers
- + Compressors
- + Conveyors
- + Fans
- + Pumps
- + Reducers

*Dimensions & Mounting
Page 181*

HP	RPM	VOLTS	FRAME	MODEL		FL AMPS	FL EFF	WT
				FOOTED	FOOTLESS			
1/4	3260	208-230 / 460	48C	AE142T11	AE142T11	0.96-0.9 / 0.43	65%	17 lbs
	1570	208-230 / 460	48C	AE144T11	AE144T11	1.14-1 / 0.52	60%	18 lbs
	1020	208-230 / 460	56C	AE146T11	AE146T11	1.35-1.2 / 0.61	56%	23 lbs
1/3	3260	208-230 / 460	48C	AE132T11	AE132T11	1.26-1.1 / 0.57	68%	18 lbs
	1595	208-230 / 460	48C	AE134T11	AE134T11	1.44-1.3 / 0.65	65%	19 lbs
1/2	3285	208-230 / 460	48C	AE122T11	AE122T11	1.81-1.6 / 0.82	70%	19 lbs
	1595	208-230 / 460	56C	AE124T11	AE124T11	2.04-1.8 / 0.92	67%	26 lbs
	1060	208-230 / 460	56C	AE126T11	AE126T11	2.37-2.1 / 1.07	62%	24 lbs
3/4	3285	208-230 / 460	48C	AE342T11	AE342T11	2.55-2.3 / 1.15	73%	20 lbs
	1665	208-230 / 460	56C	AE344T11	AE344T11	2.86-2.6 / 1.29	71.1%	28 lbs
	1060	208-230 / 460	143C	AE346T11	AE346T11	3.26-3 / 1.48	65%	27 lbs
1	3405	208-230 / 460	56C	AE12T11	AE12T11	3.34-3 / 1.51	75.1%	26 lbs
	1665	208-230 / 460	143TC	AE14T11	AE14T11	3.75-3.4 / 1.69	73.1%	29 lbs
	1090	208-230 / 460	145TC	AE16T11	AE16T11	4.19-3.8 / 1.89	69%	29 lbs
	815	208-230 / 460	182TC	AE18T11	AE18T11	4.38-4 / 1.98	71%	57 lbs
1.5	3405	208-230 / 460	143TC	AE322T11	AE322T11	4.72-4.3 / 2.13	77%	28 lbs
	1665	208-230 / 460	145TC	AE324T11	AE324T11	5.2-4.7 / 2.35	76.3%	30 lbs
	1090	208-230 / 460	182TC	AE326T11	AE326T11	5.8-5.2 / 2.62	72.1%	57 lbs
	815	208-230 / 460	184TC	AE328T11	AE328T11	6.06-5.5 / 2.74	73%	62 lbs
2	3405	208-230 / 460	145TC	AE22T11	AE22T11	6.27-5.7 / 2.84	79%	30 lbs
	1665	208-230 / 460	145TC	AE24T11	AE24T11	6.71-6.1 / 3.03	78.6%	31 lbs
	1100	208-230 / 460	184TC	AE26T11	AE26T11	7.29-6.6 / 3.3	76.1%	64 lbs
	825	208-230 / 460	213TC	AE28T11	AE28T11	8.05-7.3 / 3.64	75%	84 lbs
3	3405	208-230 / 460	145TC	AE32T11	AE32T11	8.86-8 / 4.01	81.1%	33 lbs
	1690	208-230 / 460	182TC	AE34T11	AE34T11	9.28-8.4 / 4.2	81.2%	62 lbs
	1150	208-230 / 460	213TC	AE36T11	AE36T11	9.91-9 / 4.48	81.1%	84 lbs
	845	208-230 / 460	215TC	AE38T11	AE38T11	11-10 / 4.99	78%	93 lbs
5	3455	208-230 / 460	184TC	AE52T11	AE52T11	13.8-13 / 6.25	84.4%	62 lbs
	1720	208-230 / 460	184TC	AE54T11	AE54T11	14.9-13 / 6.72	84.3%	66 lbs
	1150	208-230 / 460	215TC	AE56T11	AE56T11	16.5-15 / 7.44	82.1%	97 lbs
	860	208-230 / 460	254TC	AE58T11	AE58T11	17.4-16 / 7.85	81%	152 lbs

(Continued)

HP	RPM	VOLTS	FRAME	MODEL		FL AMPS	FL EFF	WT
				FOOTED	FOOTLESS			
7.5	3480	208-230 / 460	184TC	AE72T11	AE72T11	20.2-18 / 9.13	85.9%	86 lbs
	1725	208-230 / 460	213TC	AE74T11	AE74T11	21.4-19 / 9.69	85.8%	93 lbs
	1150	208-230 / 460	254TC	AE76T11	AE76T11	23.6-21 / 10.7	84.1%	150 lbs
	860	208-230 / 460	256TC	AE78T11	AE78T11	24.9-22 / 11.2	83%	192 lbs
10	3480	208-230 / 460	215TC	AE102T11	AE102T11	27.1-25 / 12.3	87.2%	110 lbs
	1725	208-230 / 460	215TC	AE104T11	AE104T11	28.5-26 / 12.9	87.1%	107 lbs
	1150	208-230 / 460	256TC	AE106T11	AE106T11	31.4-28 / 14.2	86.1%	161 lbs
15	3515	208-230 / 460	254TC	AE152T11	AE152T11	38.8-35 / 17.5	88.5%	150 lbs
	1750	208-230 / 460	254TC	AE154T11	AE154T11	41.1-37 / 18.6	88.5%	163 lbs
20	3515	208-230 / 460	256TC	AE202T11	AE202T11	52.3-47 / 23.6	89.5%	181 lbs
	1750	208-230 / 460	256TC	AE204T11	AE204T11	54.7-49 / 24.7	89.5%	191 lbs
25	3515	208-230 / 460	284TC	AE252T11	AE252T11	63.3-57 / 28.6	90.2%	225 lbs
	1760	208-230 / 460	284TC	AE254T11	AE254T11	66.3-60 / 30	90.1%	223 lbs
30	3525	208-230 / 460	286TC	AE302T11	AE302T11	74.8-68 / 33.8	90.7%	265 lbs
	1760	208-230 / 460	286TC	AE304T11	AE304T11	78.4-71 / 35.4	90.6%	247 lbs

CONTROLS

ENERGY STORAGE

MOTORS

PUMPS

VALVES

COMPRESSORS

PNEUMATICS

SAWMILLS

METAL RECYCLING

TRANSIT & RAILROAD

WATER & WASTEWATER

DIMENSIONS & MOUNTING

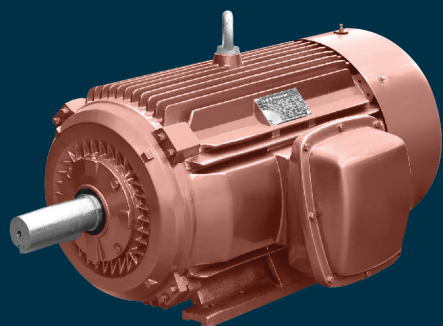

Premium Efficient Motors

TEFC Cast Iron

Foot Mount / General Purpose Motors

FEATURES

- + Premium Efficient
- + Service Factor 1.15
- + Design B
- + Class F Insulation
- + 40°C Ambient Temperature (Higher Derating Factors Available)
- + Cast Iron Frame & End Shield

APPLICATIONS

- + General Purpose in Damp & Dusty/Dirty Environments
- + Process Industries
- + Blowers
- + Compressors
- + Conveyors
- + Fans
- + Pumps

HP	RPM	VOLTS	FRAME	MODEL	FL AMPS	FL EFF	WT
1	1800	208-230 / 460	143T	PE14T01	1.43	85.5%	54 lbs
	1200	208-230 / 460	145T	PE16T01	1.73	82.5%	56 lbs
1.5	3600	208-230 / 460	143T	PE322T01	1.98	84%	45 lbs
	1800	208-230 / 460	145T	PE324T01	8	86.5%	56 lbs
2	1200	208-230 / 460	182T	PE326T01	2.39	87.5%	79 lbs
	3600	208-230 / 460	145T	PE22T01	2.65	85.5%	52 lbs
2	1800	208-230 / 460	145T	PE24T01	2.63	86.5%	58 lbs
	1200	208-230 / 460	184T	PE26T01	3.23	88.5%	97 lbs
3	3600	208-230 / 460	182T	PE32T01	3.68	87.5%	99 lbs
	1800	208-230 / 460	182T	PE34T01	3.9	89.5%	99 lbs
3	1200	208-230 / 460	213T	PE36T01	4.41	89.5%	134 lbs
	3600	208-230 / 460	184T	PE52T01	5.76	89.5%	114 lbs
5	1800	208-230 / 460	184T	PE54T01	6.4	89.5%	108 lbs
	1200	208-230 / 460	215T	PE56T01	6.83	89.5%	175 lbs
7.5	3600	208-230 / 460	213T	PE72T01	8.63	91%	134 lbs
	1800	208-230 / 460	213T	PE74T01	9.29	91.7%	165 lbs
7.5	1200	208-230 / 460	254T	PE76T01	9.73	91%	282 lbs
	3600	208-230 / 460	215T	PE102T01	11.5	91.7%	173 lbs
10	1800	208-230 / 460	215T	PE104T01	12.6	91.7%	172 lbs
	1200	208-230 / 460	256T	PE106T01	13.3	91%	316 lbs
15	3600	208-230 / 460	254T	PE152T01	16.9	91.7%	280 lbs
	1800	208-230 / 460	254T	PE154T01	18	92.4%	291 lbs
15	1200	208-230 / 460	284T	PE156T01	17.3	91.7%	360 lbs
	3600	208-230 / 460	256T	PE202T01	22.9	92.4%	313 lbs
20	1800	208-230 / 460	256T	PE204T01	24.4	93%	324 lbs
	1200	208-230 / 460	286T	PE206T01	24.1	91.7%	503 lbs
25	3600	208-230 / 460	284TS	PE252T01	28.4	93%	353 lbs
	1800	208-230 / 460	284T	PE254T01	29.5	93.6%	481 lbs
25	1200	208-230 / 460	324T	PE256T01	30.5	93%	605 lbs
	3600	208-230 / 460	256TS	PE302T01	33.4	93%	428 lbs
30	1800	208-230 / 460	286T	PE304T01	35.1	93.6%	525 lbs
	1200	208-230 / 460	326T	PE306T01	35.8	93%	673 lbs

Dimensions & Mounting
Page 174

(Continued)

HP	RPM	VOLTS	FRAME	MODEL	FL AMPS	FL EFF	WT
40	3600	208-230 / 460	324TS	PE402T01	45.8	93.6%	561 lbs
	1800	208-230 / 460	324T	PE404T01	48.3	94.1%	640 lbs
	1200	208-230 / 460	364T	PE406T01	47.1	94.1%	1076 lbs
50	3600	208-230 / 460	326TS	PE502T01	55.5	94.1%	607 lbs
	1800	208-230 / 460	326T	PE504T01	60.6	94.5%	662 lbs
	1200	208-230 / 460	365T	PE506T01	58	94.1%	1127 lbs
60	3600	208-230 / 460	364TS	PE602T01	68.3	94.1%	992 lbs
	1800	208-230 / 460	364T	PE604T01	68.4	95%	1036 lbs
	1200	208-230 / 460	404T	PE606T01	70.4	94.5%	1346 lbs
75	3600	208-230 / 460	365TS	PE752T01	82.6	95%	1025 lbs
	1800	208-230 / 460	365T	PE754T01	82.3	95.4%	1047 lbs
	1200	208-230 / 460	405T	PE756T01	87	94.5%	1478 lbs
100	3600	208-230 / 460	405TS	PE1002T01	111	95%	1361 lbs
	1800	208-230 / 460	405T	PE1004T01	112	95.4%	1302 lbs
	1200	208-230 / 460	444T	PE1006T01	121	95%	2006 lbs
125	3600	208-230 / 460	444TS	PE1252T01	133	95%	1794 lbs
	1800	208-230 / 460	444T	PE1254T01	138	95.4%	1841 lbs
	1200	208-230 / 460	445T	PE1256T01	145	95%	2082 lbs
150	3600	460	445TS	PE1502T01	161	95.4%	1865 lbs
	1800	460	445T	PE1504T01	170	95.8%	1940 lbs
	1200	460	447T	PE1506T01	174	95.8%	2738 lbs
200	3600	460	447TS	PE2002T01	221	95.8%	2072 lbs
	1800	460	447T	PE2004T01	230	96.2%	2216 lbs
	1200	460	449T	PE2006T01	223	95.8%	2506 lbs
250	3600	460	449TS	PE2502T01	269	95.8%	2364 lbs
	1800	460	449T	PE2504T01	268	96.2%	2486 lbs
	1200	460	449T	PE2506T01	289	95.8%	2667 lbs
300	3600	460	449TS	PE3002T01	324	95.8%	2454 lbs
	1800	460	449T	PE3004T01	326	96.2%	2666 lbs
350	3600	460	507TS	PE3502T01	378	95.8%	4050 lbs
	1800	460	5011LY	PE3504T01	394	96.2%	5650 lbs
400	3600	460	508TS	PE4002T01	442	95.8%	4207 lbs
	1800	460	5011LY	PE4004T01	455	96.2%	4674 lbs
	1200	460	5011LY	PE4006T01	468	95.8%	5556 lbs
450	1200	460	5011LY	PE4506T01	512	95.8%	5650 lbs
500	3600	460	509TS	PE5002T01	527	95.8%	4724 lbs
	1800	460	5011LY	PE5004T01	555	96.2%	5000 lbs

CONTROLS

ENERGY STORAGE

MOTORS

PUMPS

VALVES

COMPRESSORS

PNEUMATICS

SAWMILLS

METAL RECYCLING

TRANSIT & RAILROAD

WATER & WASTEWATER

DIMENSIONS & MOUNTING



Premium Efficient Motors TEFC Cast Iron

C-Face / General Purpose Motors

FEATURES

- + Premium Efficient
- + Service Factor 1.15
- + Design B
- + Class F Insulation
- + 40°C Ambient Temperature
- + Cast Iron Frame & End Shield

APPLICATIONS

- + General Purpose in Damp & Dusty/Dirty Environments
- + Process Industries
- + Blowers
- + Compressors
- + Conveyors
- + Fans
- + Pumps

HP	RPM	VOLTS	FRAME	MODEL		FL AMPS	FL EFF	WT
				FOOTED	FOOTLESS			
1	1800	208-230 / 460	143TC	PE14T11	PE14T21	1.43	85.5%	54 lbs
	1200	208-230 / 460	145TC	PE16T11	PE16T21	1.73	82.5%	56 lbs
1.5	3600	208-230 / 460	143TC	PE322T11	PE322T21	1.98	84%	45 lbs
	1800	208-230 / 460	145TC	PE324T11	PE324T21	2	86.5%	56 lbs
2	1200	208-230 / 460	182TC	PE326T11	PE326T21	2.39	87.5%	79 lbs
	3600	208-230 / 460	145TC	PE22T11	PE22T21	2.65	85.5%	52 lbs
2	1800	208-230 / 460	145TC	PE24T11	PE24T21	2.63	86.5%	58 lbs
	1200	208-230 / 460	184TC	PE26T11	PE26T21	3.23	88.5%	97 lbs
3	3600	208-230 / 460	182TC	PE32T11	PE32T21	3.68	87.5%	99 lbs
	1800	208-230 / 460	182TC	PE34T11	PE34T21	3.9	89.5%	99 lbs
	1200	208-230 / 460	213TC	PE36T11	PE36T21	4.41	89.5%	134 lbs
5	3600	208-230 / 460	184TC	PE52T11	PE52T21	5.76	89.5%	114 lbs
	1800	208-230 / 460	184TC	PE54T11	PE54T21	6.4	89.5%	108 lbs
7.5	1200	208-230 / 460	215TC	PE56T11	PE56T21	6.83	89.5%	175 lbs
	3600	208-230 / 460	213TC	PE72T11	PE72T21	8.63	91%	134 lbs
7.5	1800	208-230 / 460	213TC	PE74T11	PE74T21	9.29	91.7%	165 lbs
	1200	208-230 / 460	254TC	PE76T11	PE76T21	9.73	91%	282 lbs
10	3600	208-230 / 460	215TC	PE102T11	PE102T21	11.5	91.7%	173 lbs
	1800	208-230 / 460	215TC	PE104T11	PE104T21	12.6	91.7%	172 lbs
	1200	208-230 / 460	256TC	PE106T11	PE106T21	13.3	91%	316 lbs
15	3600	208-230 / 460	254TC	PE152T11	PE152T21	16.9	91.7%	280 lbs
	1800	208-230 / 460	254TC	PE154T11	PE154T21	18	92.4%	291 lbs
15	1200	208-230 / 460	284TC	PE156T11	PE156T21	17.3	91.7%	360 lbs
	3600	208-230 / 460	256TC	PE202T11	PE202T21	22.9	92.4%	313 lbs
20	1800	208-230 / 460	256TC	PE204T11	PE204T21	24.4	93%	324 lbs
	1200	208-230 / 460	286TC	PE206T11	PE206T21	24.1	91.7%	503 lbs
25	3600	208-230 / 460	284TSC	PE252T11	PE252T21	28.4	93%	353 lbs
	1800	208-230 / 460	284TC	PE254T11	PE254T21	29.5	93.6%	481 lbs
30	3600	208-230 / 460	286TSC	PE302T11	PE302T21	33.4	93%	428 lbs
	1800	208-230 / 460	286TC	PE304T11	PE304T21	35.1	93.6%	525 lbs

Dimensions & Mounting

Page 176

(Continued)

HP	RPM	VOLTS	FRAME	MODEL		FL AMPS	FL EFF	WT
				FOOTED	FOOTLESS			
40	3600	208-230 / 460	324TSC	PE402T11	-	45.8	93.6%	561 lbs
	1800	208-230 / 460	324TC	PE404T11	-	48.3	94.1%	640 lbs
50	3600	208-230 / 460	326TSC	PE502T11	-	55.5	94.1%	607 lbs
	1800	208-230 / 460	326TC	PE504T11	-	60.6	94.5%	662 lbs
60	3600	208-230 / 460	364TSC	PE602T11	-	68.3	94.1%	992 lbs
	1800	208-230 / 460	364TC	PE604T11	-	68.4	95%	1036 lbs
75	3600	208-230 / 460	365TSC	PE752T11	-	82.6	95%	1025 lbs
	1800	208-230 / 460	365TC	PE754T11	-	82.3	95.4%	1047 lbs
100	3600	208-230 / 460	405TSC	PE1002T11	-	111	95%	1361 lbs
	1800	208-230 / 460	405TC	PE1004T11	-	112	95.4%	1302 lbs
125	3600	208-230 / 460	444TSC	PE1252T11	-	133	95%	1794 lbs
	1800	208-230 / 460	444TC	PE1254T11	-	138	95.4%	1841 lbs
150	3600	460	445TSC	PE1502T11	-	161	95.4%	1865 lbs
	1800	460	445TC	PE1504T11	-	170	95.8%	1940 lbs
200	3600	460	447TSC	PE2002T11	-	221	95.8%	2072 lbs
	1800	460	447TC	PE2004T11	-	230	96.2%	2216 lbs

CONTROLS

ENERGY STORAGE

MOTORS

PUMPS

VALVES

COMPRESSORS

PNEUMATICS

SAWMILLS

METAL RECYCLING

TRANSIT & RAILROAD

WATER & WASTEWATER

DIMENSIONS & MOUNTING



Premium Efficient Motors ODP Cast Iron

Foot Mount / General Purpose Motors

FEATURES

- + Premium Efficient
- + Service Factor 1.15
- + Design B
- + Class F Insulation
- + 40°C Ambient Temperature
- + Cast Iron Frame & End Shield

APPLICATIONS

- + General Purpose in Damp & Dusty/Dirty Environments
- + Compressors
- + Fans
- + Material Handling
- + Pumps

HP	RPM	VOLTS	FRAME	MODEL	FL AMPS	FL EFF	WT
15	1800	208-230 / 460	254T	PE154D01	18.6	93%	234 lbs
	1200	208-230 / 460	284T	PE156D01	18.5	92.4%	330 lbs
20	3600	208-230 / 460	254T	PE202D01	24.6	91%	205 lbs
	1800	208-230 / 460	256T	PE204D01	25.3	93%	291 lbs
	1200	208-230 / 460	286T	PE206D01	26	92.4%	372 lbs
	3600	208-230 / 460	256T	PE252D01	28.8	93%	269 lbs
25	1800	208-230 / 460	284TS	PE254D01	29.2	94.1%	382 lbs
		208-230 / 460	284T	PE254D02	29.2	94.1%	382 lbs
	1200	208-230 / 460	324T	PE256D01	31	93.6%	478 lbs
	3600	208-230 / 460	284TS	PE302D01	31.1	93.6%	373 lbs
30	1800	208-230 / 460	286TS	PE304D01	35.4	94.1%	459 lbs
		208-230 / 460	286T	PE304D02	35.4	94.1%	459 lbs
	1200	208-230 / 460	326T	PE306D01	37	93.6%	474 lbs
40	3600	208-230 / 460	286TS	PE402D01	37.1	93.6%	457 lbs
	1800	208-230 / 460	324TS	PE404D01	45.7	94.5%	574 lbs
		208-230 / 460	324T	PE404D02	45.7	94.5%	574 lbs
	1200	208-230 / 460	364T	PE406D01	50	94.1%	827 lbs
50	3600	208-230 / 460	324TS	PE502D01	50.2	94.1%	541 lbs
	1800	208-230 / 460	326TS	PE504D01	57.3	94.5%	618 lbs
		208-230 / 460	326T	PE504D02	57.3	94.5%	618 lbs
	1200	208-230 / 460	365T	PE506D01	62	94.1%	867 lbs
60	3600	208-230 / 460	326TS	PE602D01	65	94.5%	627 lbs
	1800	208-230 / 460	364TS	PE604D01	68	95%	935 lbs
		208-230 / 460	364T	PE604D02	68	95%	935 lbs
	1200	208-230 / 460	404T	PE606D01	72	95%	1153 lbs
75	3600	208-230 / 460	364TS	PE752D01	81.5	94.5%	805 lbs
	1800	208-230 / 460	365TS	PE754D01	85.5	95%	935 lbs
		208-230 / 460	265T	PE754D02	85.5	95%	935 lbs
	1200	208-230 / 460	405T	PE756D01	88	95%	1114 lbs

Dimensions & Mounting

Page 178

(Continued)

HP	RPM	VOLTS	FRAME	MODEL	FL AMPS	FL EFF	WT
100	3600	208-230 / 460	365TS	PE1002D01	111	94.5%	935 lbs
	1800	208-230 / 460	404TS	PE1004D01	115	95.4%	1207 lbs
		208-230 / 460	404T	PE1004D02	115	95.4%	1207 lbs
	1200	208-230 / 460	444T	PE1006D01	123	95%	1472 lbs
125	3600	460	404TS	PE1252D01	132	95%	1401 lbs
	1800	460	405TS	PE1254D01	141	95.4%	1207 lbs
		460	405T	PE1254D02	141	95.4%	1207 lbs
	1200	460	445T	PE1256D01	146	95.8%	1573 lbs
150	3600	460	405TS	PE1502D01	159	94.5%	1141 lbs
	1800	460	444TS	PE1504D01	166	95.8%	1609 lbs
		460	444T	PE1504D02	166	95.8%	1609 lbs
	1200	460	445T	PE1506D01	176	95.8%	1789 lbs
200	3600	460	444TS	PE2002D01	220	95.4%	1713 lbs
	1800	460	445TS	PE2004D01	223	95.8%	1916 lbs
		460	445T	PE2004D02	223	95.8%	1916 lbs
	1200	460	447T	PE2006D01	234	95.8%	1837 lbs
250	1800	460	445T	PE2504D01	280	95.8%	1992 lbs
300	1800	460	445T	PE3004D01	335	95.8%	2010 lbs

CONTROLS

ENERGY STORAGE

MOTORS

PUMPS

VALVES

COMPRESSORS

PNEUMATICS

SAWMILLS

METAL RECYCLING

TRANSIT & RAILROAD

WATER & WASTEWATER

DIMENSIONS & MOUNTING

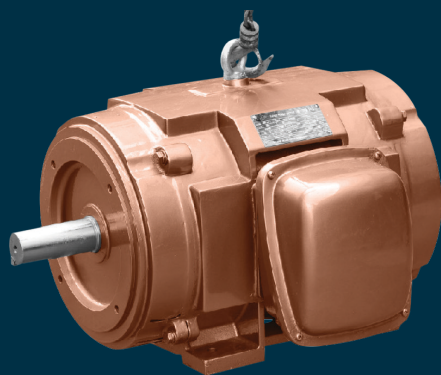

Premium Efficient Motors ODP Cast Iron

C-Face / General Purpose Motors

FEATURES

- + Premium Efficient
- + Service Factor 1.15
- + Design B
- + Class F Insulation
- + 40°C Ambient Temperature
- + Cast Iron Frame & End Shield

APPLICATIONS

- + Compressors
- + Fans
- + Material Handling
- + Pumps
- + General Purpose

HP	RPM	VOLTS	FRAME	MODEL	FL AMPS	FL EFF	WT
15	1800	208-230 / 460	254TC	PE154D11	18.6	93%	234 lbs
	1200	208-230 / 460	284TC	PE156D11	18.5	92.4%	330 lbs
20	3600	208-230 / 460	254TC	PE202D11	24.6	91%	205 lbs
	1800	208-230 / 460	256TC	PE204D11	25.3	93%	291 lbs
20	1200	208-230 / 460	286TC	PE206D11	26	92.4%	372 lbs
	3600	208-230 / 460	256TC	PE252D11	28.8	93%	269 lbs
25	1800	208-230 / 460	284TC	PE254D12	29.2	94.1%	382 lbs
	1200	208-230 / 460	324TC	PE256D11	31	93.6%	478 lbs
30	3600	208-230 / 460	284TSC	PE302D11	31.1	93.6%	373 lbs
	1800	208-230 / 460	286TC	PE304D12	35.4	94.1%	459 lbs
	1200	208-230 / 460	326TC	PE306D11	37	93.6%	474 lbs
40	3600	208-230 / 460	286TSC	PE402D11	37.1	93.6%	457 lbs
	1800	208-230 / 460	324TC	PE404D12	45.7	94.5%	574 lbs
40	1200	208-230 / 460	364TC	PE406D11	50	94.1%	827 lbs
	3600	208-230 / 460	324TSC	PE502D11	50.2	94.1%	541 lbs
50	1800	208-230 / 460	326TC	PE504D12	57.3	94.5%	618 lbs
	1200	208-230 / 460	365TC	PE506D11	62	94.1%	867 lbs
60	3600	208-230 / 460	326TSC	PE602D11	65	94.5%	627 lbs
	1800	208-230 / 460	364TC	PE604D12	68	95%	935 lbs
60	1200	208-230 / 460	404TC	PE606D11	72	95%	1153 lbs
	3600	208-230 / 460	364TSC	PE752D11	81.5	94.5%	805 lbs
75	1800	208-230 / 460	265TC	PE754D12	85.5	95%	935 lbs
	1200	208-230 / 460	405TC	PE756D11	88	95%	1114 lbs
100	3600	208-230 / 460	365TSC	PE1002D11	111	94.5%	935 lbs
	1800	208-230 / 460	404TC	PE1004D12	115	95.4%	1207 lbs

Dimensions & Mounting

Page 179

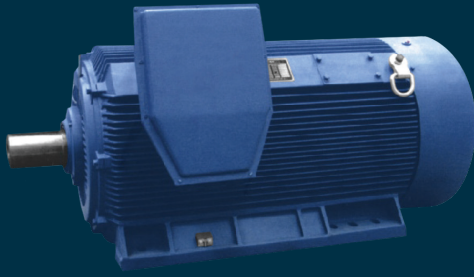

Medium Voltage Motors TEFC Cast Iron/Steel

General Purpose Motors

FEATURES

- + Low Noise, 85dBA
- + Service Factor 1.15
- + Design B
- + Class F Insulation
- + Class B Temperature Rise
- + 40°C Ambient Temperature
- + Cast Iron or Steel Frame
- + Copper Bar Rotor
- + Large Size Terminal Box

APPLICATIONS

- + Processing Applications
- + Chemical Plants
- + Waste Management Facilities
- + Severe Conditions
- + Tropical Climates

HP	RPM	VOLTS	FRAME	MODEL	FL AMPS	FL EFF	WT
350	1200	2300 / 4160	5009	MV35061	49.4	94%	4882 lbs
	1800	2300 / 4160	5007	MV35041	44.4	93.8%	4140 lbs
	3600	2300 / 4160	5007	MV35021	42.4	94%	4161 lbs
	900	2300 / 4160	5811	MV35081	50.1	94%	6787 lbs
400	1200	2300 / 4160	5010	MV40061	54.8	94.5%	5180 lbs
	1800	2300 / 4160	5008	MV40041	50.6	94%	4367 lbs
	3600	2300 / 4160	5009	MV40021	48.3	94.3%	4882 lbs
	900	2300 / 4160	5811	MV40081	57.2	94.1%	6787 lbs
450	1200	2300 / 4160	5011	MV45061	62.4	94.5%	5345 lbs
	1800	2300 / 4160	5009	MV45041	56.8	94.3%	4882 lbs
	3600	2300 / 4160	5011	MV45021	53.7	94.3%	5273 lbs
	900	2300 / 4160	5812	MV45081	63.4	94.2%	7261 lbs
500	1200	2300 / 4160	5811	MV50061	67.6	94.8%	6787 lbs
	1800	2300 / 4160	5011	MV50041	62	94.9%	5345 lbs
	3600	2300 / 4160	5811	MV50021	60.4	95.2%	6530 lbs
600	1200	2300 / 4160	5812	MV60061	80.7	95.3%	7261 lbs
	1800	2300 / 4160	5811	MV60041	75.6	95.5%	6787 lbs
	3600	2300 / 4160	5812	MV60021	72.7	95.8%	7014 lbs
700	1200	2300 / 4160	6809	MV70061	94.2	95.5%	8652 lbs
	1800	2300 / 4160	5812	MV70041	87.7	95.8%	7261 lbs
	3600	2300 / 4160	6809	MV70021	84.1	95.8%	8174 lbs
800	1200	2300 / 4160	6810	MV80061	106.3	95.7%	9084 lbs
	1800	2300 / 4160	6809	MV80041	100.8	95.7%	8404 lbs
	3600	2300 / 4160	6809	MV80021	97.1	95.8%	8174 lbs
900	1800	2300 / 4160	6810	MV90041	112.2	95.9%	8837 lbs
1000	1800	2300 / 4160	6810	MV100041	124.6	96%	8837 lbs

Dimensions & Mounting
Page 182

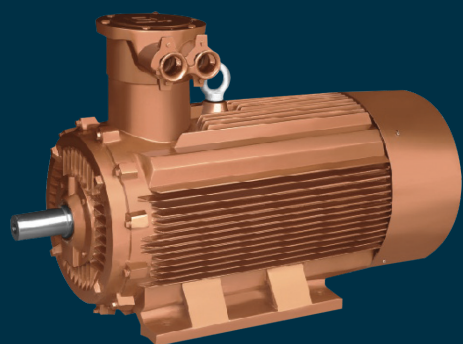

Explosion Proof Motors

TEFC

Special Purpose Motors

FEATURES

- + High Efficient
- + Class I, Group C & D
Class II, Group E, F, & G
- + Service Factor 1.15
- + Design B
- + Class F Insulation
- + 40°C Ambient Temperature
- + TEXP Enclosure

APPLICATIONS

- + Hazardous Locations
- + Compressors
- + Conveyors
- + Fans
- + Material Handling
- + Pumps

HP	RPM	VOLTS	FRAME	MODEL	FL AMPS	FL EFF	WT
1	1800	208-230 / 460	143T	EX1401	1.6	85.5%	72 lbs
1.5	1800	208-230 / 460	145T	EX32401	2.2	86.5%	73 lbs
	1200	208-230 / 460	182T	EX32601	2.2	87.5%	116 lbs
2	3600	208-230 / 460	145T	EX2201	2.6	85.5%	77 lbs
	1800	208-230 / 460	145T	EX2401	2.8	86.5%	75 lbs
	1200	208-230 / 460	184T	EX2601	2.9	88.5%	127 lbs
3	3600	208-230 / 460	182T	EX3201	3.7	86.5%	118 lbs
	1800	208-230 / 460	182T	EX3401	3.8	89.5%	124 lbs
	1200	208-230 / 460	213T	EX3601	4.1	89.5%	225 lbs
5	3600	208-230 / 460	184T	EX5201	5.8	88.5%	131 lbs
	1800	208-230 / 460	184T	EX5401	6.2	89.5%	134 lbs
7.5	1200	208-230 / 460	215T	EX5601	6.6	89.5%	287 lbs
	3600	208-230 / 460	213T	EX7201	8.6	89.5%	236 lbs
	1800	208-230 / 460	213T	EX7401	9.2	91.7%	244 lbs
10	1200	208-230 / 460	254T	EX7601	9.5	91%	363 lbs
	3600	208-230 / 460	215T	EX10201	11.5	90.2%	259 lbs
	1800	208-230 / 460	215T	EX10401	12.4	91.7%	250 lbs
15	1200	208-230 / 460	256T	EX10601	12.5	91%	379 lbs
	3600	208-230 / 460	254T	EX15201	16.7	91%	396 lbs
	1800	208-230 / 460	254T	EX15401	16.9	92.4%	404 lbs
20	1200	208-230 / 460	284T	EX15601	18	91.7%	482 lbs
	3600	208-230 / 460	256T	EX20201	22.7	91%	441 lbs
	1800	208-230 / 460	256T	EX20401	23	93%	448 lbs
25	1200	208-230 / 460	286T	EX20601	24.4	91.7%	494 lbs
	3600	208-230 / 460	284TS	EX25201	27.7	91.7%	535 lbs
	1800	208-230 / 460	284T	EX25401	27.9	93.6%	531 lbs
30	1200	208-230 / 460	324T	EX25601	30.2	93%	648 lbs
	3600	208-230 / 460	286TS	EX30201	32.8	91.7%	553 lbs
	1800	208-230 / 460	286T	EX30401	33	93.6%	538 lbs
	1200	208-230 / 460	326T	EX30601	35.4	93%	690 lbs

(Continued)

HP	RPM	VOLTS	FRAME	MODEL	FL AMPS	FL EFF	WT
40	3600	208-230 / 460	324TS	EX40201	44.9	92.4%	669 lbs
	1800	208-230 / 460	324T	EX40401	45.5	94.1%	690 lbs
	1200	208-230 / 460	364T	EX40601	47.1	94.1%	937 lbs
50	3600	208-230 / 460	326TS	EX50201	56	93%	715 lbs
	1800	208-230 / 460	326T	EX50401	57	94.5%	736 lbs
	1200	208-230 / 460	365T	EX50601	59	94.1%	978 lbs
60	3600	208-230 / 460	364TS	EX60201	67.5	93.6%	896 lbs
	1800	208-230 / 460	364T	EX60401	68.5	95%	947 lbs
	1200	208-230 / 460	404T	EX60601	69.5	94.5%	1282 lbs
75	3600	208-230 / 460	365TS	EX75201	82.5	93.6%	952 lbs
	1800	208-230 / 460	365T	EX75401	83.5	95.4%	1014 lbs
	1200	208-230 / 460	405T	EX75601	84.5	94.5%	1359 lbs
100	3600	208-230 / 460	405TS	EX100201	112	94.1%	1344 lbs
	1800	208-230 / 460	405T	EX100401	113	95.4%	1390 lbs
	1200	460	444 / 5T	EX100601	115	95%	1610 lbs
125	3600	460	444 / 5TS	EX125201	134	95%	1673 lbs
	1800	460	444 / 5T	EX125401	134	95.4%	1601 lbs
	1200	460	444 / 5T	EX125601	138	95%	1792 lbs
150	3600	460	444 / 5TS	EX150201	164	95%	1771 lbs
	1800	460	444 / 5T	EX150401	163	95.8%	1792 lbs
	1200	460	447 / 9T	EX150601	167	95.8%	2008 lbs
200	3600	460	444 / 5TS	EX200201	223	95.4%	1874 lbs
	1800	460	455 / 7 / 9T	EX200401	223	96.2%	2049 lbs
	1200	460	477 / 9T	EX200601	233	95.8%	2662 lbs

CONTROLS

ENERGY STORAGE

MOTORS

PUMPS

VALVES

COMPRESSORS

PNEUMATICS

SAWMILLS

METAL RECYCLING

RAILROAD & TRANSIT

WATER & WASTEWATER

DIMENSIONS & MOUNTING



Stainless Steel Motors

TEFC

C-Face / Special Purpose Motors

FEATURES

- + Service Factor 1.15
- + Design B
- + Class F Insulation
- + Lip Seals
- + Four Condensation Drains in each End Plate
- + 300 Series Stainless Steel Frame, End Plates, Shaft, Base, & Conduit Box

APPLICATIONS

- + Corrosive Environments
- + Food Processing
- + Outdoors
- + Packaging

HP	RPM	VOLTS	FRAME	MODEL		FL AMPS	FL EFF	WT
				FOOTED	FOOTLESS			
1/3	3600	208-230 / 460	56C	SS13401	SS13411	0.6	79.8%	41 lbs
	1800	208-230 / 460	56C	SS12201	SS12211	0.84	78.3%	42 lbs
1/2	3600	208-230 / 460	56C	SS12401	SS12411	0.87	81.2%	48 lbs
	1200	208-230 / 460	56C	SS12601	SS12611	0.91	79.1%	63 lbs
3/4	3600	208-230 / 460	56C	SS34201	SS34211	1.17	81.9%	47 lbs
	1800	208-230 / 460	56C	SS34401	SS34411	1.25	81.3%	53 lbs
	1200	208-230 / 460	56C	SS34601	SS34611	1.29	82.9%	68 lbs
1	3600	208-230 / 460	56C	SS1201	SS1211	1.48	83.3%	58 lbs
		208-230 / 460	56C	SS1401	SS1411	1.58	82.3%	60 lbs
	1800	208-230 / 460	56C	SS1402	SS1412	1.5	82.3%	60 lbs
		208-230 / 460	143TC	SS1403	SS1413	1.5	82.5%	75 lbs
		208-230 / 460	143TC	SS1404	SS1414	1.5	82.5%	75 lbs
1.5	3600	208-230 / 460	56C	SS32201	SS32211	2.05	82.3%	64 lbs
		208-230 / 460	143TC	SS32202	SS32212	2	82.5%	72 lbs
	1800	208-230 / 460	56C	SS32401	SS32411	2.01	82%	65 lbs
		208-230 / 460	145TC	SS32402	SS32412	2.2	84%	70 lbs
2	3600	208-230 / 460	56C	SS2201	SS2211	2.62	83%	73 lbs
		208-230 / 460	145TC	SS2202	SS2212	2.7	84%	82 lbs
	1800	208-230 / 460	56C	SS2401	SS2411	2.69	85%	78 lbs
		208-230 / 460	145TC	SS2402	SS2412	2.8	84%	80 lbs
3	3600	208-230 / 460	145TC	SS3201	SS3211	3.8	84%	90 lbs
		208-230 / 460	182TC	SS3202	SS3212	3.8	85.5%	95 lbs
	1800	208-230 / 460	182TC	SS3401	SS3411	3.9	87.5%	102 lbs
5	3600	208-230 / 460	184TC	SS5201	SS5211	6.1	87.5%	116 lbs
	1800	208-230 / 460	184TC	SS5401	SS5411	6.5	87.5%	130 lbs
7.5	3600	208-230 / 460	213TC	SS7201	SS7211	8.9	88.5%	175 lbs
	1800	208-230 / 460	213TC	SS7401	SS7411	9.4	89.5%	190 lbs
10	3600	208-230 / 460	215TC	SS10201	SS10211	11.8	89.5%	202 lbs
	1800	208-230 / 460	215TC	SS10401	SS10411	12.5	90.2%	207 lbs

Dimensions & Mounting

Page 186

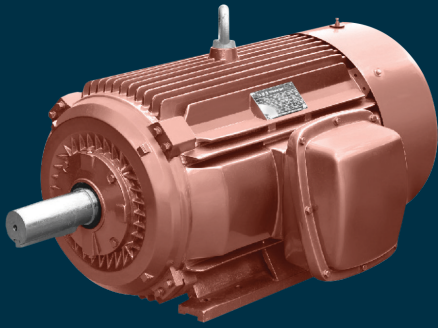

Crusher Duty Motors ODP

Foot Mount / Special Purpose Motors

FEATURES

- + High Efficient
- + Service Factor 1.15
- + Design C High Torque
- + Class F Insulation
- + Drive End Roller Bearing
- + Not Suitable for Direct Coupled Drive

APPLICATIONS

- + Belt Driven Rock Crushers
- + Pellet Mills
- + Severe Duty Services
- + High Starting Torque

HP	RPM	VOLTS	FRAME	MODEL	FL AMPS	FL EFF	WT
100	1800	208-230 / 460	405T	CU10041	115	94.5%	1184 lbs
	1200	208-230 / 460	444T	CU10061	121	94.1%	1061 lbs
125	1800	208-230 / 460	444T	CU12541	144	94.5%	1344 lbs
	1200	208-230 / 460	445T	CU12561	148	94.1%	1750 lbs
150	1800	208-230 / 460	445T	CU15041	166	95%	1637 lbs
	1200	208-230 / 460	445 / 7T	CU15061	176	95%	1851 lbs
200	1800	208-230 / 460	445 / 7T	CU20041	230	95.2%	2750 lbs
	1200	460	449T	CU20061	241	95%	2583 lbs
250	1800	460	449T	CU25041	282	95%	2583 lbs
		460	505Z	CU25042	276	94.8%	2429 lbs
		460	505UZ	CU25043	276	94.8%	2429 lbs
	1200	460	449T	CU25061	300	95.4%	2832 lbs
		460	586 / 7	CU25062	289	94.5%	3806 lbs
		460	586 / 7UZ	CU25063	289	94.5%	3806 lbs
300	1800	460	449T	CU30041	334	95.7%	2809 lbs
		460	586 / 7	CU30042	323	95%	3897 lbs
		460	586 / 7UZ	CU30043	323	95%	2914 lbs
	1200	460	449T	CU30061	355	94.5%	2914 lbs
		460	586 / 7	CU30062	337	95.2%	4260 lbs
		460	586 / 7UZ	CU30063	337	95.2%	4260 lbs
350	1800	460	586 / 7	CU35041	378	95.8%	4078 lbs
		460	586 / 7UZ	CU35042	378	95.8%	4078 lbs
	1200	460	586 / 7	CU35061	390	95.1%	4269 lbs
		460	586 / 7UZ	CU35062	390	95.1%	4269 lbs
400	1800	460	586 / 7	CU40041	430	95.3%	4224 lbs
		460	586 / 7UZ	CU40042	430	95.3%	4224 lbs
	1200	460	586 / 7	CU40061	448	95%	4540 lbs
		460	586 / 7UZ	CU40062	448	95%	4540 lbs
450	1800	460	586 / 7	CU45041	478	96.1%	4635 lbs
	1200	460	586 / 7	CU45061	501	95.8%	4635 lbs
500	1800	460	586 / 7	CU50041	539	95.8%	4768 lbs
		460	586 / 7UZ	CU50042	539	95.8%	4768 lbs
	1200	460	586 / 7	CU50061	557	95%	4882 lbs
		460	586 / 7UZ	CU50062	557	95%	4882 lbs

Dimensions & Mounting
Page 183

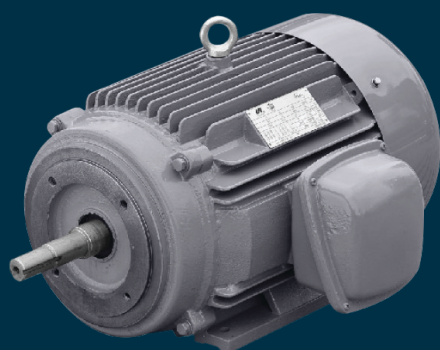

Close-Coupled Pump Motors

TEFC

Definite Purpose Motors

FEATURES

- + Service Factor 1.15
- + Design B
- + Class F Insulation
- + 40°C Ambient Temperature
- + Oversized Ball Bearing with Locked Drive End

APPLICATIONS

- + Circulating/Transferring Fluids

HP	RPM	VOLTS	JM		JP		FL AMPS	FL EFF	WT
			FRAME	MODEL	FRAME	MODEL			
1	1800	208-230 / 460	143JM	CCP14M1	143JP	CCP14P1	1.49	82.5%	47 lbs
	3600	208-230 / 460	143JM	CCP322M1	143JP	CCP322P1	1.99	82.5%	45 lbs
1.5	1800	208-230 / 460	145JM	CCP324M1	145JP	CCP324P1	2.05	84%	54 lbs
	3600	208-230 / 460	145JM	CCP22M1	145JP	CCP22P1	2.6	84%	47 lbs
2	1800	208-230 / 460	145JM	CCP24M1	145JP	CCP24P1	2.7	84%	56 lbs
	3600	208-230 / 460	145JM	CCP32M1	145JP	CCP32P1	3.8	84.5%	67 lbs
3	1800	208-230 / 460	182JM	CCP32M2	182JP	CCP32P2	3.59	85.5%	103 lbs
	3600	208-230 / 460	182JM	CCP34M1	182JP	CCP34P1	3.9	87.5%	97 lbs
5	3600	208-230 / 460	184JM	CCP52M1	184JP	CCP52P1	5.9	87.5%	114 lbs
	1800	208-230 / 460	184JM	CCP54M1	184JP	CCP54P1	6.48	87.5%	102 lbs
7.5	3600	208-230 / 460	184JM	CCP72M1	184JP	CCP72P1	8.66	82.5%	126 lbs
	1800	208-230 / 460	213JM	CCP72M2	213JP	CCP72P2	8.6	88.5%	150 lbs
10	1800	208-230 / 460	213JM	CCP74M1	213JP	CCP74P1	9.53	88.5%	150 lbs
	3600	208-230 / 460	215JM	CCP102M1	215JP	CCP102P1	11.7	89.5%	150 lbs
15	1800	208-230 / 460	215JM	CCP104M1	215JP	CCP104P1	12.8	89.5%	165 lbs
	3600	208-230 / 460	215JM	CCP152M1	215JP	CCP152P1	17	90.2%	168 lbs
20	1800	208-230 / 460	254JM	CCP152M2	254JP	CCP152P2	17	90.2%	280 lbs
	3600	208-230 / 460	254JM	CCP154M1	254JP	CCP154P1	17.9	90.2%	266 lbs
25	1800	208-230 / 460	256JM	CCP202M1	256JP	CCP202P1	24.4	91%	313 lbs
	3600	208-230 / 460	256JM	CCP204M1	256JP	CCP204P1	23.5	91%	470 lbs
30	1800	208-230 / 460	256JM	CCP252M1	256JP	CCP252P1	29	91%	277 lbs
	3600	208-230 / 460	284JM	CCP252M2	284JP	CCP252P2	29	91%	353 lbs
40	1800	208-230 / 460	284JM	CCP254M1	284JP	CCP254P1	29.6	92.4%	437 lbs
	3600	208-230 / 460	286JM	CCP302M1	286JP	CCP302P1	33.8	91%	404 lbs
50	1800	208-230 / 460	286JM	CCP304M1	286JP	CCP304P1	34.4	92.4%	481 lbs
	3600	208-230 / 460	324JM	CCP402M1	324JP	CCP402P1	46.1	91.7%	561 lbs
50	1800	208-230 / 460	324JM	CCP404M1	324JP	CCP404P1	47.6	93%	587 lbs
	3600	208-230 / 460	326JM	CCP502M1	326JP	CCP502P1	56.5	92.4%	594 lbs
50	1800	208-230 / 460	326JM	CCP504M1	326JP	CCP504P1	57.8	93.6%	640 lbs

Dimensions & Mounting

Page 184

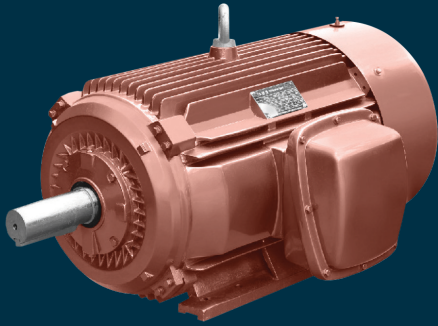

Oil Well Pump Motors TEFC

Definite Purpose Motors

FEATURES

- + Service Factor 1.15
- + Design D
- + Class F Insulation
- + 40°C Ambient Temperature
- + TEFC Enclosure

APPLICATIONS

- + Beam Pumps
- + Sucker Rod Pumps
- + High Torque / High Slip

HP	RPM	VOLTS	FRAME	MODEL	FL AMPS	FL EFF	WT
3	1120	230 / 460 / 796	213T	OWP11	8.8 / 4.4 / 2.5	81.8%	157 lbs
5	1125	230 / 460 / 796	215T	OWP51	14.6 / 7.3 / 4.2	82.3%	177 lbs
7.5	1120	230 / 460 / 796	254T	OWP71	21.6 / 10.8 / 6.3	86.5%	298 lbs
10	1120	230 / 460 / 796	256T	OWP101	29.0 / 14.5 / 8.4	86.6%	322 lbs
15	1120	230 / 460 / 796	284T	OWP151	41.4 / 20.7 / 12	87.7%	417 lbs
20	1120	230 / 460 / 796	286T	OWP201	54 / 27 / 15.6	87.7%	459 lbs
25	1125	230 / 460 / 796	324T	OWP251	65.2 / 32.6 / 18.8	88.4%	611 lbs
30	1120	230 / 460 / 796	326T	OWP301	78 / 39 / 22.5	88.7%	668 lbs
40	1120	230 / 460 / 796	365T	OWP401	100 / 50 / 28.9	88.9%	807 lbs
50	1120	230 / 460 / 796	404T	OWP501	123 / 61.5 / 35.5	89.9%	997 lbs
60	1120	230 / 460 / 796	405T	OWP601	145.2 / 72.6 / 42	89.9%	1087 lbs
75	1140	230 / 460 / 796	444T	OWP751	185.2 / 92.6 / 53.5	90.6%	1431 lbs
100	1140	230 / 460 / 796	445T	OWP1001	242 / 121 / 69.9	91%	1751 lbs

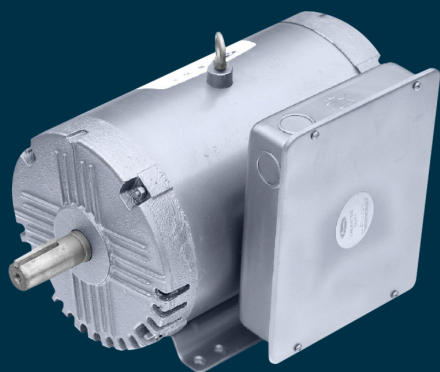

Air Compressor Motors ODP

Definite Purpose Motors

APPLICATIONS

- + Single-Phase Compressors

HP	RPM	VOLTS	FRAME	MODEL	SF	FL AMPS	OVERLOAD
1.5	3600	115 / 230	56	A843	1	22 / 11	Manual
2	3600	115 / 230	56	A874	1	24 / 12	Manual
3	3600	230	56	A867	1	15	Manual
5	3600	208-230	56HZ	A976	1.15	22	Manual
7.5	3600	208-230	184T	A1057	1.15	34.3 / 31.0	None

FEATURES

- + Class B Insulation
- + 40°C Ambient Temperature
- + Manual Reset Thermal Overload Protector
- + Rigid Base
- + ODP Enclosure



CONTROLS

ENERGY STORAGE

MOTORS

PUMPS

VALVES

COMPRESSORS

PNEUMATICS

SAWMILLS

METAL RECYCLING

TRANSIT & RAILROAD

WATER & WASTEWATER

DIMENSIONS & MOUNTING

PUMPS





Industrial Service Solutions

CONTROLS
ENERGY STORAGE
MOTORS
PUMPS
VALVES
COMPRESSORS
PNEUMATICS
SAWMILLS
METAL RECYCLING
TRANSIT & RAILROAD
WATER & WASTEWATER
DIMENSIONS & MOUNTING



Pump Field Services

Industrial Service Solutions is available around-the-clock for your unplanned maintenance and emergency repairs. Whether its excessive vibration or operational issues, our highly skilled technicians have the know-how and independent capabilities to troubleshoot, diagnose, and yield solutions for all pump types, brands, and applications. With a fleet of service vehicles, including 53-foot mobile tooling trailers, we are fully equipped to machine, weld, fabricate, test, and repair equipment onsite.

- + 24/7 Emergency Service
- + Preventative Maintenance
- + Mechanical & Electrical Repairs
- + Machining & Part Fabrication
- + Onsite Flange Facing
- + Bearing & Seal Replacement
- + Packing Replacement
- + Installation & Rigging Service
- + Precision Laser Alignment
- + Start-up & Troubleshooting
- + Performance Testing
- + Vibration Analysis
- + Dynamic Balancing
- + Infrared Thermal Imaging

Pump Repairs & Overhauls

When a pump issue cannot be addressed in the field, our repair shops across the United States are fully equipped and ready to service any industrial pump. Our experts have extensive OEM knowledge and often receive pumps our competitors do not or will not repair. We repair pumps to like-new condition, usually better than new, with tighter tolerances, and enhanced efficiency. Our technicians can recommend upgrades to prolong your pump's lifespan and our engineers can design a customized pump system if you need more capacity. Even if parts are unavailable, our machinists have the capability to manufacture custom parts on demand to keep your downtime to a minimum.

- | | | |
|------------------------|-----------------------------|-----------------------------|
| + <i>ANSI Pumps</i> | + <i>Axial Flow Pumps</i> | + <i>End Suction Pumps</i> |
| + <i>Gear Pumps</i> | + <i>Booster Pumps</i> | + <i>Multi-Screw Pumps</i> |
| + <i>In-line Pumps</i> | + <i>Diaphragm Pumps</i> | + <i>Multi-Stage Pumps</i> |
| + <i>Lobe Pumps</i> | + <i>Centrifugal Pumps</i> | + <i>Non-Metallic Pumps</i> |
| + <i>Mixers</i> | + <i>Grinder Pumps</i> | + <i>Self-Priming Pumps</i> |
| + <i>Slurry Pumps</i> | + <i>Progressive Cavity</i> | + <i>Sliding Vane Pumps</i> |
| + <i>Trash Pumps</i> | + <i>Split Case Pumps</i> | + <i>Submersible Pumps</i> |
| + <i>Well Pumps</i> | + <i>Turbine Pumps</i> | |



Before



After

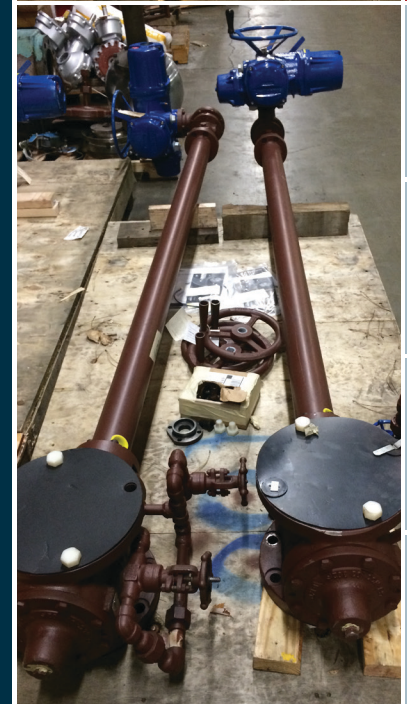

CONTROLS

ENERGY STORAGE

MOTORS

PUMPS

VALVES

COMPRESSORS

PNEUMATICS

SAWMILLS

METAL RECYCLING

TRANSIT & RAILROAD

WATER & WASTEWATER

DIMENSIONS & MOUNTING

Brands We Represent

Industrial Service Solutions is a distributor of pumps for all types of industrial, municipal, and commercial applications. We provide distribution for the major OEMs below.



* Some brands may not be available in all geographic areas.

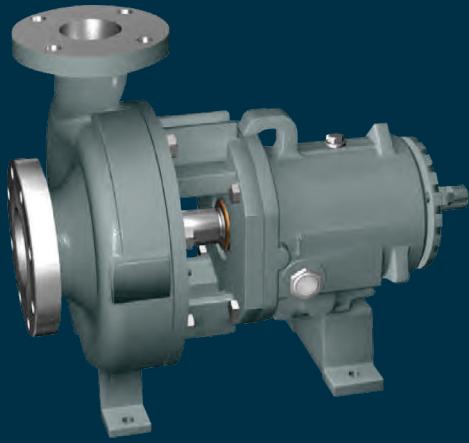

MP-3 ANSI Centrifugal Pumps

Equivalent to Flowserve Durco Mark III

APPLICATIONS

- + Acid Transfer
- + Brine
- + Chemical Processing
- + Petrochemical Processing
- + Corrosive Services
- + Food & Beverage Processing
- + Hydrocarbon Processing
- + Pharmaceuticals

G1 SIZES	1.5x1LF-4, 1.5x1-6, 3x1.5-6, 3x2-6, 1.5x1LF-8, 1.5x1-8, 3x1.5-8
G2 SIZES	3x2-8, 4x3-8, 2x1LF-10, 2x1-10A, 3x1.5-10A, 3x2-10A, 4x3-10, 4x3-10H, 6x4-10, 6x4-10H, 3x1.5LF-13, 3x1.5-13, 3x2-13, 4x3-13, 4x3-13HH, 6x4-13A
G3 SIZES	8x6-14A, 10x8-14, 6x4-16, 8x6-16A, 10x8-16, 10x8-16H, 10x8-17
FLOW	to 7,000 GPM
HEADS	to 730 FT
PRESSURES	to 375 PSI
TEMPERATURES	to 700°F
STANDARDS	ISO-9001, ANSI B73.1
CONFIGURATIONS	Standard, Low Flow, Recessed Impeller, Self-Priming

FEATURES

- + Heavy-duty casing with integral foot and multi-ribbed discharge flange provides superior resistance to pipe loads and improves reliability
- + Precision cast reverse vane impeller is the only impeller design that offers repeatable pump performance throughout the life of the pump
- + Open impellers available
- + Seal chamber extends seal life and provides advanced self-flushing capability
- + Standard non-contacting labyrinth seals keep lubricant in and contaminants out
- + Heavy-duty radial and thrust bearings selected for long life and reliability
- + External micrometer impeller adjustment mechanism accurately sets impeller clearance in 20 seconds
- + Two-piece, ductile iron bearing housing is designed for safety, strength, interchangeability and retrofit capability
- + Back pull-out design allows removal of rotating element without removing casing, piping, or motor



MP-6913 ANSI Centrifugal Pumps

Equivalent to ITT Goulds 3196

APPLICATIONS

- + Air Separation & HVAC
- + Chemical & Petrochemical
- + Grain/Corn Processing
- + Power Generation
- + Pulp & Paper
- + Marine & Shipbuilding

SIZES	1x1.5-6, 1.5x3-6, 2x3-6, 3x4-7, 1x1.5-8, 1.5x3-8, 2x3-8, 3x4-8, 3x4-8G, 1x2-10, 1.5x3-10, 2x3-10, 3x4-10, 3x4-10H, 4x6-10, 4x6-10H, 1.5x3-13, 2x3-13, 3x4-13, 4x6-13, 6x8-13, 8x10x13, 6x8-15, 8x10-15, 8x10-15G
FLOW	to 7,000 GPM
HEADS	to 730 FT
PRESSURES	to 375 PSI
TEMPERATURES	to 700°F
STANDARDS	ISO-9001, ANSI B73.1
CONFIGURATIONS	Standard, Low Flow, Recessed Impeller

FEATURES

- + Easier to automate than gate valves, often easier than rotary valves
- + Lower installation cost and higher performance than gate valves
- + Provides reliability and tight shut-off under many damaging process conditions
- + Can easily be adapted to comply with evolving emission regulations
- + Positive shaft retention prevents movement of the shaft past the compression plate
- + Flexible-lip polymeric seat assures positive shut-off, extending life cycle
- + Only the insert needs to be removed to replace the seat; the insert and seat are self-aligning
- + Low torque requirements allow the use of less costly actuators
- + Available in a broad range of materials for standard and special services including chlorine, oxygen, cryogenics, and vacuum.

Performance

Page 191

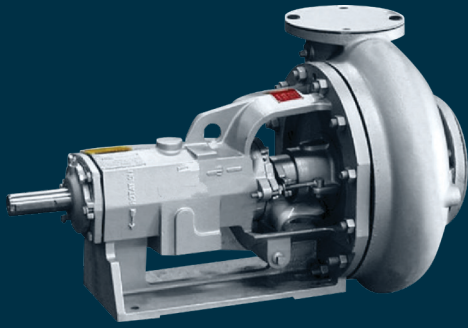

MP-MAG-I Centrifugal Pumps

Equivalent to MISSION Magnum

APPLICATIONS

- + Ash or Coal Conveyors
- + Barite, Ferric Oxide, Mineral Oil
- + Base Drilling Muds
- + Cement
- + Crystalline Forms
- + Glass Fibers
- + Kaolin Clay
- + Lime Slurries
- + Mine De-Watering
- + Sugar Processing

SIZES	6x5-11, 8x6-11, 3x2-13, 4x3-13, 5x4-14, 6x5-14, 8x6-14, 10x8-14
FLOW	to 2,600 GPM
HEADS	to 550 FT

FEATURES

- + Up to 50% more capacity from the 8x6 pump
- + Optimum pressure at low operating speeds
- + Thicker casing to extend life from wear and corrosion
- + New impeller design to reduce loads and extend wearing life
- + Larger and stronger shaft to reduce deflection
- + Replaceable shaft sleeve in packing wear area
- + Larger and longer life bearings
- + Replaceable stuffing box cover
- + Smoother, non-turbulent flow throughout casing

*Dimensions
Page 192*



MP-MAG-XP

Centrifugal Pumps

Equivalent to MISSION Magnum XP

APPLICATIONS

- + Blending
- + Bottom Ash
- + Copper, Bauxite, Quarry Slurries
- + Dredge Tailings
- + Fluid Supercharging
- + Fly Ash
- + Food Processing
- + Lead & Zinc Ore & Tailings
- + Nickel Shot
- + Paper Pulp Processing
- + Sand Slurry
- + Sewage
- + Slag
- + Spent Liquor
- + Waste Slurries

SIZES	14x12-22, 12x10-23, 8x6-18
PRESSURES	from 3,000 to 7,500 GPM
HEADS	from 75 to 410 FT

FEATURES

- + Versatile stuffing box
- + One-piece casing
- + Casing gasket receded for protection
- + Back vanes reduce collection of solids at stuffing box
- + Long-life, no-adjustment mechanical seal available for near zero leakage
- + Replaceable shaft sleeve
- + Lip seals for maximum bearing protection (labyrinth seals optional)
- + Duplex angular contact bearings
- + Thicker, stronger concentric casings
- + Full pipe diameter entrance for minimum turbulence and maximum efficiency
- + Single row roller bearings for increased bearing life
- + Easily accessible front access drain
- + Reduced high bearing loads

Dimensions

Page 193

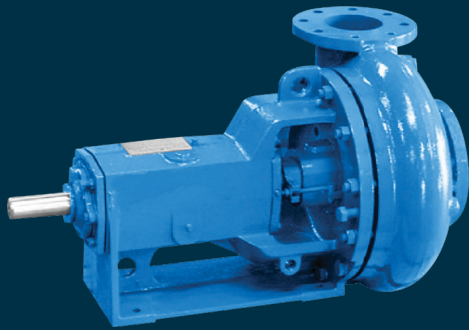

MP-2500 Centrifugal Pumps

Equivalent to MISSION 2500 Supreme

APPLICATIONS

- + Ash or Coal Conveyors
- + Barite, Ferric Oxide, Mineral Oil
- + Base Drilling Muds
- + Cement
- + Crystalline Forms
- + Glass Fibers
- + Kaolin Clay
- + Lime Slurries
- + Mine De-Watering
- + Sugar Processing

SIZES	6x5-11, 8x6-11, 3x2-13, 4x3-13, 5x4-14, 6x5-14, 8x6-14, 10x8-14
FLOW	to 2,600 GPM
HEADS	to 550 FT

FEATURES

- + Versatile stuffing box
- + Thick, strong, concentric casing with replaceable casing wear pad
- + Casing gasket recessed for protection
- + Replaceable stuffing box cover with dual stuffing box bolts
- + Long-life, no-adjustment mechanical seal available for near zero leakage
- + Replaceable shaft sleeve
- + Solid frame base
- + Labyrinth seals for maximum bearing protection
- + Duplex angular contact bearings
- + Full pipe diameter entrance for minimum turbulence and maximum efficiency
- + Wide semi-open impeller creates lower axial thrust for improved bearing life
- + All sizes feature the same power cord

Dimensions

Page 194



MP-MChr Centrifugal Pumps

Equivalent to MISSION Magnachrome

APPLICATIONS

- + Ash or Coal Conveyors
- + Barite, Ferric Oxide, Mineral Oil
- + Base Drilling Muds
- + Cement
- + Crystalline Forms
- + Glass Fibers
- + Kaolin Clay
- + Lime Slurries
- + Mine De-Watering
- + Sugar Processing

SIZES	6x5-11, 8x6-11, 3x2-13, 4x3-13, 5x4-14, 6x5-14, 8x6-14, 10x8-14
FLOW	to 2,600 GPM
HEADS	to 550 FT

FEATURES

- + High grade, heavy walled, solid construction offering superior performance over lined pumps and those using inserts
- + One power frame fits all sizes
- + Double row angular contact bearings to minimize axial thrust
- + Double row inboard bearings to minimize effects of radial load
- + Greater capacity and higher heads for extremely abrasive fluids



MP-SandM Centrifugal Pumps

Equivalent to MISSION Sandmaster

APPLICATIONS

- + Air Separation & HVAC
- + Chemical & Petrochemical
- + Grain/Corn Processing
- + Power Generation
- + Pulp & Paper
- + Marine & Shipbuilding

SIZES	6x5-11, 8x6-11, 3x2-13, 4x3-13, 5x4-14, 6x5-14, 8x6-14, 10x8-14
FLOW	to 2,600 GPM
HEADS	to 550 FT

FEATURES

- + More compact design than MP-MAG-I
- + Can be adapted for hydraulic motor drive
- + Up to 50% more capacity from the 8x6 pump
- + Optimum pressure at low operating speeds
- + Thicker casing to extend life from wear and corrosion
- + New impeller design to reduce loads and extend wearing life
- + Larger and stronger shaft to reduce deflection
- + Replaceable shaft sleeve in packing wear area
- + Larger and longer life bearings
- + Replaceable stuffing box cover
- + Smoother, non-turbulent flow throughout casing

*Dimensions
Page 195*



MP-LJC Vertical Turbine Pumps

Equivalent to ITT Goulds VTP

APPLICATIONS

- + Boiler Feed
- + Chemical Transfer
- + Condensate Service
- + Cryogenics
- + Injection Secondary Recovery
- + Light Hydrocarbons
- + LNG Transfer
- + Pipeline Booster
- + Product Transfer
- + Refinery Blending
- + Water Services

MODEL	CAPACITY M ³ /H	HEAD M			STAGE I	STRING QTY MM	RPM	kW	EFF	DIA MM	
		44	40	32							
100MPLJC10-4	6.5	44	40	32	10	8	2940	5.5	62	92	
		52.5	44	35	11						
		53	48	38	12						
		58	52	41.5	13						
		61.5	56	44.5	14						
		66	60	48	15						
	10	70	64	51	16						
		74.5	68	54	17						
		79	72	57.5	18						
		83.5	76	60.5	19						
		88	80	64	20						
		92	84	67	21						
		12	96.5	88	70						22
			102	92	73.5						23
105.5	96		76.5	24							
110	100		80	25							
115	104		83	26							
150MPLJC10-9	8		56	54	40	6	12	2940	5.5	62	138
		65	63	47	7						
		74.5	72	54	8						
	10	84	80	61	9						
		93	89	67.5	10						
		102.5	98	61.5	11						
		112	108	81	12						
		16	121	117	87.5	13					
			130	126	94.5	14					
			139.5	135	101	15					
			149	144	108	16					
					7.5						
				11							

FEATURES

- + Fabricated discharge head and flanged column
- + Flanged bowl construction and 416SS shafting
- + In-line suction and discharge simplifies installation
- + Optional suction in can for site piping flexibility
- + Inherent design features allow efficient operation at any NPSH available
- + Alloy construction with external flush of critical wear areas available for corrosive/abrasive services
- + Built-in alignment and simple piping for less costly installation and ease of maintenance/reduced downtime

Dimensions

Page 196



MPP High Efficiency Slurry Pumps

Equivalent to Weir Warman AH

APPLICATIONS

- + Cooling & Heating Systems
- + Desalination Plants
- + Fire Protection
- + Irrigation & Drainage
- + Long Distance Water Supply
- + Marine & Offshore Engineering
- + Power Stations
- + Pressure Boosting
- + Water Transport
- + Water Utilities

SIZES	TBD
FLOW	TBD
HEADS	TBD
PRESSURES	TBD
TEMPERATURES	from -40°F to 250°F
HORSEPOWER	to 1,500 HP
STANDARDS	ISO-9001, ISO-9002

FEATURES

- + Single case construction without shaft seal provides easy installation and maintenance
- + Pump casing, cover, and impeller are made of 28% chrome (ASTM A532) cast iron to ensure wear resistance
- + Single volute design for low constant radial loads and a tapered fitting between the case and cover for easy assembly and disassembly
- + Open or closed impeller with twisted vanes for high efficiency and good flow conditions to ensure even wear
- + Heavy shaft and no shaft seal for severe operating conditions
- + Pump and motor can be directly coupled or connected with belts



MP-DS Double Suction Split Case Pumps

Equivalent to ITT Goulds 3420

APPLICATIONS

- + Cooling & Heating Systems
- + Desalination Plants
- + Fire Protection
- + Irrigation & Drainage
- + Long Distance Water Supply
- + Marine & Offshore Engineering
- + Power Stations
- + Pressure Boosting
- + Water Transport
- + Water Utilities

SIZES	14 to 48 IN
FLOW	to 79,260 GPM (higher rates available)
HEADS	to 1,800 FT
PRESSURES	to 1,015 PSI
TEMPERATURES	to 175°F
STANDARDS	API 610, ANSI B73.1

FEATURES

- + Horizontal or vertical installation with double entry radial impeller
- + Mating flanges to DIN, ISO, BS, or ANSI
- + High operating reliability and excellent efficiencies keep operating costs down
- + Service friendly design to the world's highest standards on quality, safety, reliability, and durability
- + Low maintenance costs and high availability
- + Sustainable pump design with low life cycle costs

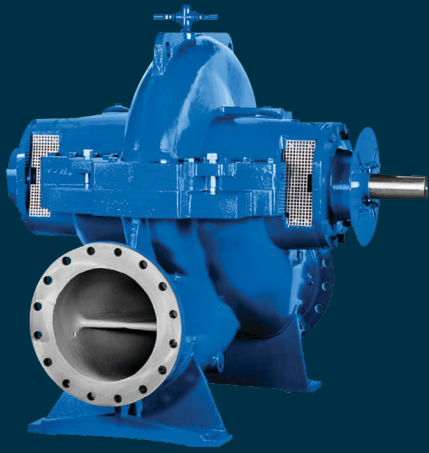

MP-ANSI Double Suction Split Case Pumps

Equivalent to ITT Goulds 3410

APPLICATIONS

- + Cooling & Heating Systems
- + Desalination Plants
- + Fire Protection
- + Irrigation & Drainage
- + Long Distance Water Supply
- + Marine & Offshore Engineering
- + Power Stations
- + Pressure Boosting
- + Water Transport
- + Water Utilities

SIZES	3 to 14 IN
FLOW	to 12,680 GPM (higher rates available)
HEADS	to 690 FT
PRESSURES	to 360 PSI
TEMPERATURES	to 285°F
STANDARDS	API 610, ANSI B73.1

FEATURES

- + Horizontal or vertical installation with double entry radial impeller
- + Mating flanges to DIN, ISO, BS, or ANSI
- + High operating reliability and excellent efficiencies keep operating costs down
- + Service friendly design to the world's highest standards on quality, safety, reliability, and durability
- + Low maintenance costs and high availability
- + Sustainable pump design with low life cycle costs

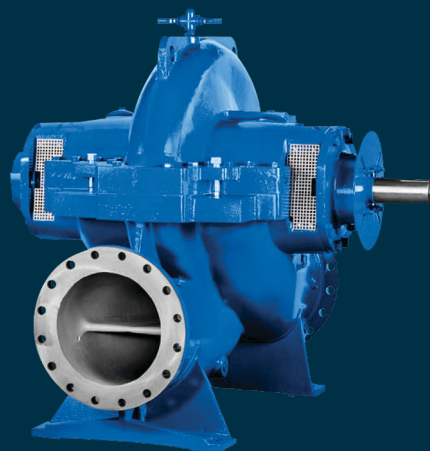

MP-DSP Double Suction Split Case Pumps

Equivalent to ITT Goulds 3415

APPLICATIONS

- + Cooling & Heating Systems
- + Desalination Plants
- + Fire Protection
- + Irrigation & Drainage
- + Long Distance Water Supply
- + Marine & Offshore Engineering
- + Power Stations
- + Pressure Boosting
- + Water Transport
- + Water Utilities

SIZES	14 to 28 IN
FLOW	to 44,000 GPM (higher rates available)
HEADS	to 790 FT
PRESSURES	to 360 PSI
TEMPERATURES	to 285°F
STANDARDS	API 610, ANSI B73.1

FEATURES

- + Horizontal or vertical installation with double entry radial impeller
- + Mating flanges to DIN, ISO, BS, or ANSI
- + High operating reliability and excellent efficiencies keep operating costs down
- + Service friendly design to the world's highest standards on quality, safety, reliability, and durability
- + Low maintenance costs and high availability
- + Sustainable pump design with low life cycle costs



SH Series Submersible HD Pumps

Equivalent to Tsurumi HS Series

APPLICATIONS

- + General Purpose
- + Civil Engineering & Construction Works
- + Mines, Quarries, Coal Ore, & Slurries
- + Sewage Treatment Plants

FEATURES

- + Capacity up to 372m³/h
- + Head up to 295'
- + 30 HP to 60 HP
- + Class F Insulation
- + IP68 Protection Class
- + 65' Cable Length (optional)
- + 40°C Ambient Temperature
- + 98' Max Water Depth

MODEL 50/60Hz	OUTLET		POWER		CURR	CAPACITY		HEAD	MAX CAPACITY		MAX HEAD	IMPELLER PASSAGE
	MM	HP	KW	A	M ³ /H	M ³ /MIN	M	M ³ /H	M ³ /MIN	M	MM	
SH422	100	30	22	41.5	66	1.1	60	130/138	2.17/2.3	68	6	
SH430	100	40	30	54	72	1.2	70/75	170/144	2.83/2.4	78/82	6	
SH622	150	30	22	41.5	120	2.0	37/40	200/210	3.33/3.5	50/52	15	
SH630	150	40	30	54	140	2.33	45/48	220/216	3.67/3.6	58/64	15	
SH637	150	50	37	66	60	1.0	80	220	3.67	83	6	
SH645	150	60	45	80	84	1.4	80	220	3.67	90	6	
SH837	200	50	37	66	216	3.6	35	330	5.5	48	20	
SH845	200	60	45	80	270	4.5	35	372	6.2	53	20	



KBZ Series Submersible Drainage Pumps

APPLICATIONS

- + General Purpose
- + Civil Engineering
- + Mines, Quarries, Coal Ore, & Slurries
- + Sewage Treatment Plants

FEATURES

- + Capacity up to 160m³/h
- + Head up to 187'
- + 2 HP to 20 HP
- + Class F Insulation
- + IP68 Protection Class
- + 26' Cable Length (optional)
- + 40°C Ambient Temperature
- + 82' Max Water Depth

MODEL 50Hz	OUTLET	POWER		CURR 380V	CAPACITY		HEAD	MAX CAPACITY		MAX HEAD	IMPELLER PASSAGE
	MM	HP	KW	A	M ³ /H	M ³ /MIN	M	M ³ /H	M ³ /MIN	M	MM
KBZ21.5	50	2	1.5	3.5	15	0.25	16.5	27	0.45	23	8.5
KBZ31.5	80	2	1.5	3.5	30	0.5	9	45	0.75	15	8.5
KBZ22.2	50	3	2.2	5.1	18	0.3	20	31	0.52	28	8.5
KBZ32.2	80	3	2.2	5.1	30	0.6	13	47	0.78	20.5	8.5
KBZ23.7	50	5	3.7	8	12	0.2	30	50	0.83	33	8.5
KBZ33.7	80	5	3.7	8	30	0.5	22	55	0.92	31	8.5
KBZ43.7	100	5	3.7	8	60	1	11.5	96	1.6	18.5	8.5
KBZ35.5	80	7.5	5.5	11.6	36	0.6	25	69	1.15	38	8.5
KBZ45.5	100	7.5	5.5	11.6	60	1	16	102	1.7	24.4	8.5
KBZ47.5	100	10	7.5	15.4	48	0.8	30	80	1.33	41	11.5
KBZ67.5	150	10	7.5	15.4	90	1.6	15	127	2.12	31	19.5
KBZ411	100	15	11	22.5	60	1	35	84	1.4	48.5	11.5

MODEL 60Hz	OUTLET	POWER		CURR 400V	CAPACITY		HEAD	MAX CAPACITY		MAX HEAD	IMPELLER PASSAGE
	MM	HP	KW	A	M ³ /H	M ³ /MIN	M	M ³ /H	M ³ /MIN	M	MM
KBZ21.5	50	2	1.5	3.5	15	0.25	15	27	0.45	22	8.5
KBZ31.5	80	2	1.5	3.5	30	0.5	8	40	0.67	14.5	8.5
KBZ22.2	50	3	2.2	5.0	18	0.3	20	33	0.55	26	8.5
KBZ32.2	80	3	2.2	5.0	36	0.6	11	55	0.92	19	8.5
KBZ23.7	50	5	3.7	7.7	12	0.2	30	33	0.55	34	8.5
KBZ33.7	80	5	3.7	7.7	30	0.5	20	55	0.92	29	8.5
KBZ43.7	100	5	3.7	7.7	60	1	11.5	90	1.5	18.5	8.5
KBZ35.5	80	7.5	5.5	11.4	36	0.6	25	75	1.25	34	8.5
KBZ45.5	100	7.5	5.5	11.4	60	1	16	105	1.75	23	8.5
KBZ47.5	100	10	7.5	15	48	0.8	30	84	1.4	40	11.5
KBZ67.5	150	10	7.5	15	90	1.6	15	124.8	2.08	31	19.5
KBZ411	100	15	11	22	60	1	35	84	1.4	48.5	11.5

Dimensions & Performance
Page 188

VALVES





Industrial Service Solutions

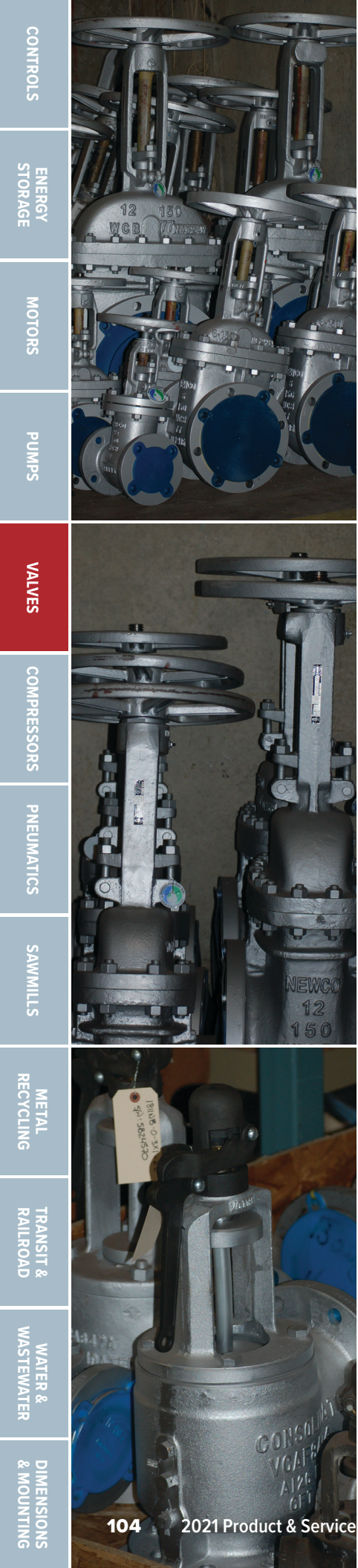

CONTROLS

ENERGY STORAGE

MOTORS

PUMPS

VALVES

COMPRESSORS

PNEUMATICS

SAWMILLS

METAL RECYCLING

TRANSIT & RAILROAD

WATER & WASTEWATER

DIMENSIONS & MOUNTING

Valve Maintenance & Repair

With more than 300 highly skilled and certified technicians, the most field service trailers in the industry, and strategically located regional repair shops, Industrial Service Solutions is fully equipped to service and support your valves' entire life cycle. We deliver a wide range of onsite services from valve testing and inspection to maintenance including machining and welding to parts procurement and upgrades. Our factory authorized repair centers offer full-service repairs, reconditioning, modifications, testing and inspection services for all brands, types, and sizes of valves and actuators.

- + *Ball Valves*
- + *In-line Valves*
- + *Safety Valves*
- + *Butterfly Valves*
- + *Manual Valves*
- + *Switch Valves*
- + *Check Valves*
- + *Mixing Valves*
- + *Vent Valves*
- + *Control Valves*
- + *MOV Valves*
- + *Electric Actuators*
- + *Gate Valves*
- + *Plug Valves*
- + *Hydraulic Actuators*
- + *Globe Valves*
- + *Pressure Relief*
- + *Pneumatic Actuators*

Service Technicians Trained to Diagnose, Service, & Repair

- + *Anderson Greenwood*®
- + *CCI*®
- + *Masoneilan*®
- + *Atwood & Morrill*®
- + *Conval*®
- + *Newco*®
- + *Auma*®
- + *Crosby*®
- + *ORBIT*®
- + *Centerline*®
- + *Durco*®
- + *Rotork*®
- + *Chapman*®
- + *Edwards*®
- + *Shand & Jurs*®
- + *Conbraco*®
- + *Farris*®
- + *Valtek*®
- + *Consolidated*®
- + *Fisher*®
- + *Velan*®
- + *Crane / Pacific*®
- + *Flowseal*®
- + *WedgePlug*®
- + *General Twin Seal*®
- + *Limitorque*®
- + *Weir*®
- + *HBE Engineering*®



Valve Shop Services

We can service, repair, and remanufacture all brands, types, sizes, and applications of valves, including block, control, and pressure relief valves. Our authorized repair centers are available 24/7 and ready to work with your operations and engineering personnel on process requirements, optimize valve repair vs replace decisions, and improve valve performance in the field. We can also coordinate with maintenance and planning to schedule work to procure parts and equipment to complete the project on time and within budget.

- + *OEM Authorized Service Center*
- + *24/7 Emergency Repairs*
- + *Preventative Maintenance*
- + *Reconditioning & Remanufacturing*
- + *OEM Parts Procurement*
- + *Part Reverse Engineering*
- + *Valve Seat Machining & Grinding*
- + *Valve Fabrication & Welding*
- + *New Valve Modifications*
- + *Manual to MOV Conversions*
- + *Flange Face Conversions*
- + *Actuator Sizing & Assembly*
- + *In-line Testing with Lift Assist*
- + *Non-Destructive Testing*
- + *Warehouse Storage*
- + *Online Asset Tracking*
- + *Class 9 Cleanroom*

CERTIFICATIONS

- + National Board VR Stamp
- + National Board ASME Section I & VIII
- + Limitorque "Blue Ribbon" Service Center
- + Consolidated Authorized Green Tag Center

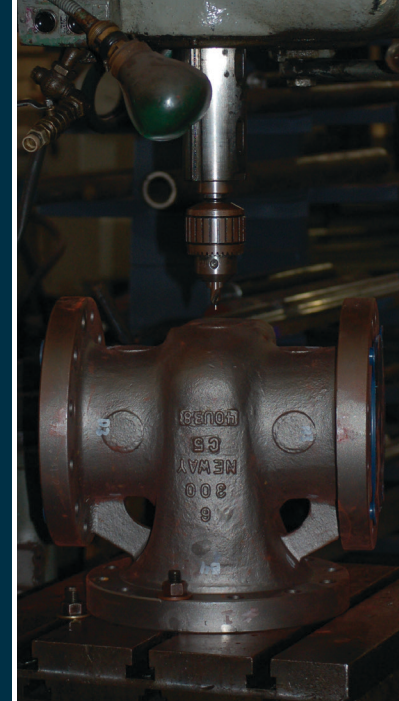

CONTROLS

ENERGY STORAGE

MOTORS

PUMPS

VALVES

COMPRESSORS

PNEUMATICS

SAWMILLS

METAL RECYCLING

TRANSIT & RAILROAD

WATER & WASTEWATER

DIMENSIONS & MOUNTING

CONTROLS
ENERGY STORAGE
MOTORS
PUMPS
VALVES
COMPRESSORS
PNEUMATICS
SAWMILLS
METAL RECYCLING
TRANSIT & RAILROAD
WATER & WASTEWATER
DIMENSIONS & MOUNTING

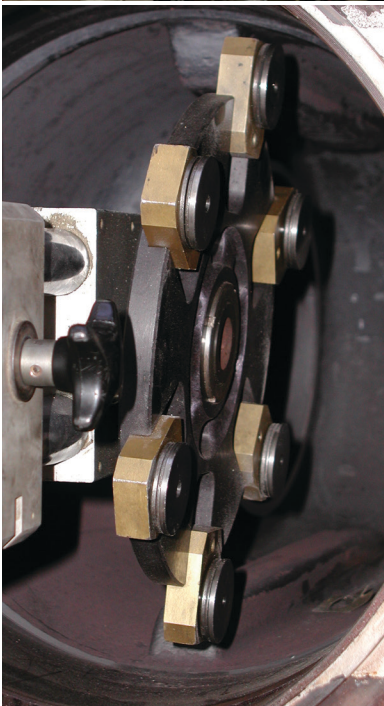

Valve Field Service

Industrial Service Solutions' fleet of 48 to 53 foot mobile tooling trailers are fully equipped for inline machining, part fabrication, welding, actuation repair, and live-steam testing to National Board standards. Onsite we can service any valve type, brand, size, material, pressure, and operating condition. In addition to valve repair and maintenance, our field service team excels at larger projects, including turnarounds, outages, upgrades, and installations. Whatever the time, location, or complexity of a project, Industrial Service Solutions has the field service know-how and equipment to do the job safely, on schedule, and within budget.

- + 24/7 Emergency Service
- + Preventative Maintenance
- + Turnarounds & Outages
- + Start-up & Troubleshooting
- + Upgrades & Installation
- + Part Procurement/Management
- + Onsite Part Fabrication
- + Non-Destructive Testing
- + Modifications & Retrofits
- + In-line Machining & Welding
- + Valve Seat Hard Facing
- + Stem Polishing & Coating
- + Mechanical Support & Bolt-Up
- + Valve Repacking Services
- + Leak Detection & Repair (LDAR)
- + Testing & Calibration

Comprehensive Valve Testing

Our technicians use advanced methods of testing to reduce downtime cost while preserving the safety and integrity of your valves. All test stands at our repair facilities are certified by the National board, including mobile test stands used in the field. We can test air at 6,000 psi, nitrogen at 6,000 psi, water at 8,000 psi, and steam at 1,500 psi. If you need in-line testing for pressure and safety relief valves, we have EVT and AVK test units and can setup specific test programs, including linkage to ValvKeep for future preventative maintenance.



New & Reconditioned Valve Products & Parts

Industrial Service Solutions has an extensive inventory of new valve products and a large supply of valves on-hand ready to be reconditioned. Our experienced product specialists select and size the correct valve products, even in critical safety and control valve applications. If a new or reconditioned valve isn't the right solution, our in-house valve repair services provide fast, high-quality turnarounds.



CONTROLS

ENERGY STORAGE

MOTORS

PUMPS

VALVES

COMPRESSORS

PNEUMATICS

SAWMILLS

METAL RECYCLING

TRANSIT & RAILROAD

WATER & WASTEWATER

DIMENSIONS & MOUNTING

Brands We Represent

Industrial Service Solutions is a distributor of pumps for all types of industrial, municipal, and commercial applications. We provide distribution for the major OEMs below.



* Some brands may not be available in all geographic areas.

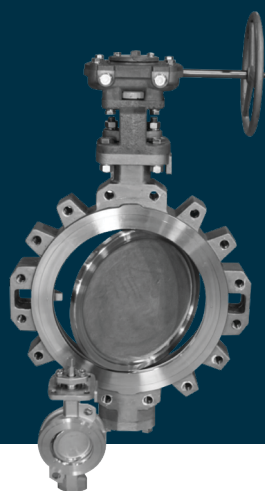

High Performance Double Offset Butterfly Valves

Equivalent to ABZ, Bray, Crane, Durco, & Jamesbury

APPLICATIONS

- + Air Separation & HVAC
- + Chemical & Petrochemical
- + Grain/Corn Processing
- + Power Generation
- + Pulp & Paper
- + Marine & Shipbuilding

SIZES	2 to 24 IN (up to 60 IN available)
PRESSURES	ANSI Class 150, 300, 600
TEMPERATURES	from -196°F to 550°F
BODY STYLE	Wafer, Lug, Flanged
BODY MATERIAL	Cast Steel, Stainless Steel
SEAT MATERIAL	PTFE, EPDM, NBR, Metal Seated
DESIGN STANDARD	API 609, MSS SP-67, BS 5155, EN 593, DIN 3354
FLANGE DRILLING	ASME B16.5, ASME B16.47, DIN 2501, EN 1092
TESTING STANDARD	API 598, EN 12266
FACE-TO-FACE	API 609, DIN 3202

FEATURES

- + Easier to automate than gate valves, often easier than rotary valves
- + Lower installation cost and higher performance than gate valves
- + Provides reliability and tight shut-off under many damaging process conditions
- + Can easily be adapted to comply with evolving emission regulations
- + Positive shaft retention prevents movement of the shaft past the compression plate
- + Flexible-lip polymeric seat assures positive shut-off, extending life cycle
- + Only the insert needs to be removed to replace the seat; the insert and seat are self-aligning
- + Low torque requirements allow the use of less costly actuators
- + Available in a broad range of materials for standard and special services including chlorine, oxygen, cryogenics, and vacuum.



Series 1200 Butterfly Valves

Equivalent to Crane Series 200

APPLICATIONS

- + Air Separation & HVAC
- + Food & Beverage
- + Chemical & Petrochemical
- + Power Generation
- + Pulp & Paper

SIZES	2 to 48 IN
PRESSURES	to 200 PSI
TEMPERATURES	to 300°F
BODY STYLE	Wafer, Lug, Flanged
BODY MATERIAL	Cast Iron, Ductile Iron, Stainless Steel
SEAT MATERIAL	PTFE, EPDM
DESIGN STANDARD	API 609, MSS SP-67
FLANGE DRILLING	ASME B16.5
TESTING STANDARD	API 598
FACE-TO-FACE	API 609

FEATURES

- + Flange accommodates all types of actuators: handle, gear, electric, and pneumatic
- + Smooth finished disc flats mate with seat flats to give a highly efficient seal; prevents leakage into shat areas
- + Strong precision key gives positive attachment for handles or actuators
- + One-piece through shaft ensures dependability and positive disc positioning
- + Bonding of elastomer to phenolic backing ring protects against distortion, a common cause of leakage
- + Seat face negates need for flange gaskets
- + Precision profile disc provides bubble-tight shut-off and assures minimum torque and longer seat life
- + Phenolic backed seat is non-collapsible, stretch resistant, blow out proof, and easily replaced in the field



C-KGA Slurry Knife Gate Valves

Equivalent to Clarkson KGA

APPLICATIONS

- + Cement & Aggregates
- + Chemical & Petrochemical
- + Mining & Metals
- + Power Generation
- + Pulp & Paper

SIZES	2 to 54 IN
PRESSURES	to 100 PSI
TEMPERATURES	to 400°F

FEATURES

- + 100% full port
- + Double seated, bidirectional shut-off design
- + Heavy duty elastomer sleeves
- + No seat cavity
- + Packingless design
- + Manual bevel gear
- + Air or hydraulic cylinder actuators
- + Electric motor operators



C-KGD Slurry Knife Gate Valves

Equivalent to Clarkson KGD

APPLICATIONS

- + Cement & Aggregates
- + Chemical & Petrochemical
- + Mining & Metals
- + Power Generation
- + Pulp & Paper

SIZES	2 to 24 IN
PRESSURES	to 150 PSI
TEMPERATURES	to 300°F

FEATURES

- + 100% full port
- + Double seated, bidirectional shut-off design
- + Exclusive, dynamic self-adjusting sleeve design
- + MSS face-to-face dimension
- + Manual bevel gear
- + Air or hydraulic cylinder actuators
- + Electric motor operators



C-KGF Slurry Knife Gate Valves

Equivalent to Clarkson KGF

APPLICATIONS

- + Cement & Aggregates
- + Chemical & Petrochemical
- + Mining & Metals
- + Power Generation
- + Pulp & Paper

SIZES	3 to 36 IN
PRESSURES	to 300 PSI
TEMPERATURES	to 300°F

FEATURES

- + 300 psi CWP Design
- + 100% full port
- + Double seated, bidirectional shut-off design
- + Exclusive, dynamic self-adjusting sleeve design
- + Manual bevel gear
- + Air or hydraulic cylinder actuators
- + Electric motor operators



C-KLB Linear Line Blind Valves

Equivalent to Clarkson KLB

APPLICATIONS

- + Cement & Aggregates
- + Chemical & Petrochemical
- + Mining & Metals
- + Power Generation
- + Pulp & Paper

SIZES	2 to 24 IN
PRESSURES	to 150 PSI
TEMPERATURES	to 300°F

FEATURES

- + Man-safe line blind
- + No downstream leakage even with sleeve failure
- + 100% full port
- + Double seated, bidirectional shut-off design
- + MSS face-to-face dimension
- + Positive splash containment
- + Manual bevel gear
- + Air or hydraulic cylinder actuators
- + Electric motor operators



C-Valve Slurry Throttling Valves

Equivalent to Clarkson C-Valve

APPLICATIONS

- + Cement & Aggregates
- + Chemical & Petrochemical
- + Mining & Metals
- + Power Generation
- + Pulp & Paper

SIZES	1 to 10 IN (larger sizes available)
PRESSURES	to 100 PSI
TEMPERATURES	to 400°F

FEATURES

- + No metal parts in contact with the flowing slurry
- + Molded elastomer sleeve
- + Sleeve maintains perfect round and concentric aperture across the full throttling range
- + Throttling range from wide open to up to a 90% reduction of maximum flow
- + Automated or manual valve actuation
- + Valve sizing and applications assistance available

COMPRESSORS





Industrial Service Solutions

CONTROLS

ENERGY STORAGE

MOTORS

PUMPS

VALVES

COMPRESSORS

PNEUMATICS

SAWMILLS

METAL RECYCLING

TRANSIT & RAILROAD

WATER & WASTEWATER

DIMENSIONS & MOUNTING



Compressor Field Services

Industrial Service Solutions' nationwide network of field experts and fully equipped service vehicles, including 53-foot mobile tooling trailers, are available around-the-clock for your unplanned maintenance and emergency repairs. Our tenured, highly skilled, and often factory-trained technicians have the know-how and independent capabilities to troubleshoot, diagnose, and yield solutions for all compression equipment types, brands, and applications. At Industrial Service Solutions, our personnel are supported by a flex workforce of vetted talent for unmatched response and turnaround times.

- + *Emergency Support*
- + *Onsite Repairs & Overhauls*
- + *Maintenance & Inspections*
- + *Machining & Fabrication*
- + *Rigging & Installation*
- + *Systems Integration*
- + *Troubleshooting & Testing*
- + *Service Agreements*

Compressor Repair Shops

Our high-capacity shops are fully equipped to service and repair all compressor types and brands to your exact specifications, on time, and within budget. Whether it's a complete overhaul or a single part, our technicians have the technical expertise and tailored processes to deliver equipment better than new, with tighter tolerances and enhanced efficiency. For emergency repairs, our shops are available around-the-clock to machine and fabricate unavailable or obsolete parts.

- + *Repairs & Overhauls*
- + *Certified Remanufacturing*
- + *Machining & Fabrication*
- + *Part Engineering & Procurement*
- + *Retrofits & Upgrades*
- + *Dynamic Balancing*
- + *Troubleshooting & Testing*
- + *Rental Program*



Quality Parts & Equipment

Industrial Service Solutions is committed to providing optimal compressor performance through a wide range of OEM and high-quality aftermarket parts and lubricants. Our extensive inventory includes new, used, and certified refurbished parts from most major manufacturers. In addition to competitively priced spare parts, we provide consultative support for improved reliability, performance, and emissions.

- + *Centrifugal Parts*
- + *Rotary Screw Parts*
- + *Consumables*
- + *Reciprocating Parts*
- + *Components*

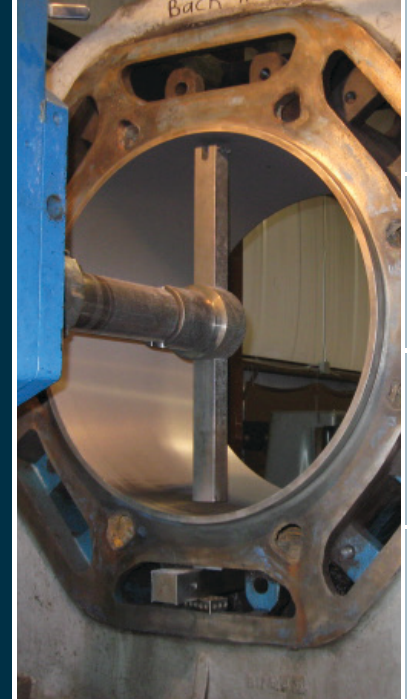

CONTROLS

ENERGY STORAGE

MOTORS

PUMPS

VALVES

COMPRESSORS

PNEUMATICS

SAWMILLS

METAL RECYCLING

TRANSIT & RAILROAD

WATER & WASTEWATER

DIMENSIONS & MOUNTING



Centrifugal Compressors



Shop Online at
ISS-NA.com/Products

SERVICES

- + Nationwide field service with fully equipped mobile tooling trailers for onsite compressor repairs and complete overhauls.
- + **Complete Overhaul Capability** with turret lathes, horizontal and vertical mills, cylindrical and surfacing grinding, and dynamic balancing
- + **Air End Assembly Repairs** include disassembly, cleaning, inspection, blending of erosion damage, replacement of impellers, pinions, diffusers, bearings, seals, O-rings, gaskets, and fasteners as required, reassembly, balancing, and painting.
- + **Rotor Assembly Repairs** include disassembly, cleaning, inspection, blending of erosion damage, replacing impeller/pinions, reassembly, and balancing.
- + **Bull gear Repairs** include inspection, grind-plate-grind, blending of damaged teeth, and balancing.
- + **Gearbox Repairs** include...
- + **Inlet Repairs** include disassembly, cleaning, inspection, machining, painting, and reassembly of eroded/corroded parts.
- + **Bearing Repairs** include fixed profile pinion and bull gear bearings, remove and replace babbit, and recondition bearing to new specifications.
- + **Cooler Repairs** include cleaning, hydro testing, tube expanding, tube bundles or re-tube, and tube plugging.
- + **Ingersoll Rand Centac Intercooler Capabilities** include testing and cleaning fixtures for all frames, re-tubing, barrel repairs, blasting and painting, and sleeve sealing surfaces with stainless steel surfaces.
- + Complete Rental Fleet

BRANDS WE REPRESENT





Reciprocating Compressors



Shop Online at
ISS-NA.com/Products

SERVICES

- + Nationwide field service with fully equipped mobile tooling trailers for onsite compressor repairs and complete overhauls.
- + **Complete Overhaul Capability** turret lathes, horizontal and vertical mills, cylindrical and surfacing grinding, and dynamic balancing
- + **Air End Assembly Repairs** include disassembly, cleaning, inspection, blending of erosion damage, replacement of impellers, pinions, diffusers, bearings, seals, O-rings, gaskets, and fasteners as required, reassembly, balancing, and painting.
- + **Cylinder Repairs** include boring, honing, cold metal stitching up to 50" diameter. Pattern casting capability when manufacturing new cast iron cylinders.
- + **Piston/Rod Repairs** include machining all tolerances, re-establishing diametrical running clearances by metallizing OD with babbitt/bronze, and Teflon conversions.
- + **Bearing Repairs** include fixed profile pinion and bull gear bearings, remove and replace babbitt, and recondition bearing to new specifications.
- + **Cooler Repairs** include cleaning, hydro testing, tube expanding, tube bundles or re-tube, and tube plugging.
- + **Motor Repairs**
- + **Control Designs & Retrofits**
- + **Oil Pump Repairs**
- + **Laser Alignment**
- + **Complete Rental Fleet**

BRANDS WE REPRESENT





Rotary Screw Compressors



Shop Online at
ISS-NA.com/Products

SERVICES

- + Nationwide field service with fully equipped mobile tooling trailers for onsite compressor repairs and complete overhauls.
- + **Complete Overhaul Capability** turret lathes, horizontal and vertical mills, cylindrical and surfacing grinding, and dynamic balancing
- + **Air End Assembly Repairs** include disassembly, cleaning, inspection, blending of erosion damage, replacement of impellers, pinions, diffusers, bearings, seals, O-rings, gaskets, and fasteners as required, reassembly, balancing, and painting.
- + **Bearing Repairs** include fixed profile pinion and bull gear bearings, remove and replace babbit, and recondition bearing to new specifications.
- + **Cooler Repairs** include cleaning, hydro testing, tube expanding, tube bundles or re-tube, and tube plugging.
- + **Motor Repairs**
- + **Control Designs & Retrofits**
- + **Oil Pump Repairs**
- + **Laser Alignment**
- + **Complete Rental Fleet**

BRANDS WE REPRESENT



CHAMPION



**Gardner
Denver**



KOBELCO

**KAESER
COMPRESSORS**



**Sullivan
Palatek
AIR COMPRESSORS**



Compressor Replacement Parts



Shop Online at
ISS-NA.com/Products

COMPONENTS

- + Coolers
- + Dryers
- + Blowers
- + Motors
- + Pumps
- + Controls
- + Impellers
- + Cylinders
- + Pistons & Rods
- + Hoses

CONSUMABLES

- + Lubricants
- + Filters
- + Separators
- + Valves
- + Gaskets
- + O-Rings
- + Bearings & Seals
- + Maintenance Kits

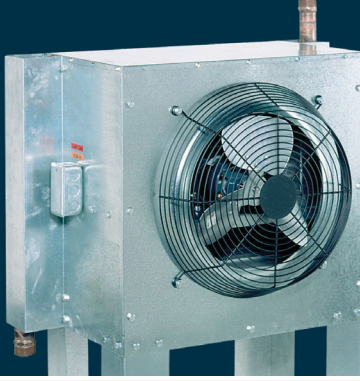

Coolers



Aftercoolers



Oil Coolers

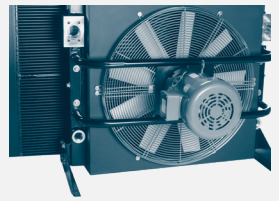

Combination Air/Oil Coolers

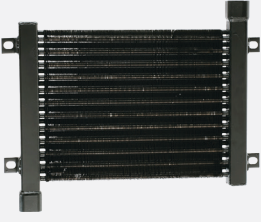

Belt Guard Aftercoolers



Skid Packaged Coolers

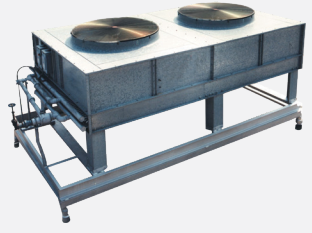

Liquid Coolers



Shop Online at
ISS-NA.com/Products

BRANDS WE REPRESENT



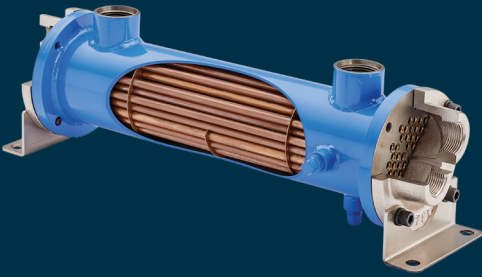

Shell & Tube Heat Exchangers



Shop Online at
ISS-NA.com/Products

SERVICES

- + Nationwide field service with fully equipped mobile tooling trailers for onsite heat exchanger repairs and complete overhauls.
- + **Shell and Water Head Repairs** include blasting, machining sealing surfaces, pass partition repair, and epoxy coating.
- + **Tube Repairs** include cleaning, hydro testing, tube expanding, tube bundles or re-tube, and tube plugging.
- + **Manufacturing** new tube bundles and complete tube and shell coolers

BRANDS WE REPRESENT





Air/Gas Dryers



Desiccant Dryers



Refrigerated Dryers



Membrane Dryers



Deliquescent Dryers



Breathing Air Dryers



Point of Use Dryers



Shop Online at
ISS-NA.com/Products

BRANDS WE REPRESENT



CONTROLS
 ENERGY STORAGE
 MOTORS
 PUMPS
 VALVES
 COMPRESSORS
 PNEUMATICS
 SAWMILLS
 METAL RECYCLING
 TRANSIT & RAILROAD
 WATER & WASTEWATER
 DIMENSIONS & MOUNTING



Filtration



Filter Elements



Filter Assemblies



Mist Eliminators



Air/Oil Separators



Oil/Water Separators



Centrifugal Separators



Shop Online at
ISS-NA.com/Products

BRANDS WE REPRESENT





Lubricants & Chemicals



Shop Online at
ISS-NA.com/Products

WE SUPPLY

- + Compressor Oils
- + Refrigeration Oils
- + Food Grade Lubricants
- + Gear & Bearing Oils
- + Hydraulic Oils
- + Pump & Blower Oils
- + Heat Transfer Fluids
- + Cleaners/Flush
- + Descalers & Degreasers

BRANDS WE REPRESENT





CONTROLS

ENERGY STORAGE

MOTORS

PUMPS

VALVES

COMPRESSORS

PNEUMATICS

SAWMILLS

METAL RECYCLING

TRANSIT & RAILROAD

WATER & WASTEWATER

DIMENSIONS & MOUNTING

PNEUMATICS





Industrial Service Solutions

- CONTROLS
- ENERGY STORAGE
- MOTORS
- PUMPS
- VALVES
- COMPRESSORS
- PNEUMATICS**
- SAWMILLS
- METAL RECYCLING
- TRANSIT & RAILROAD
- WATER & WASTEWATER
- DIMENSIONS & MOUNTING



Pneumatic Design & Engineering

Industrial Service Solutions has an extensive background in the design of both high-pressure or positive displacement conveying systems, low-pressure conveying systems, dust collection systems, and environmental fume control systems and equipment. We have been one of the leading pneumatic suppliers for over 35 years and have designed, fabricated, and installed hundreds of pneumatic systems throughout the United States.



Environmental Systems

Industrial Service Solutions has designed, fabricated, and installed hundreds of environmental fume control systems to the unique needs of our customers. From dust collectors to regenerative thermal oxidizers, our systems are built to protect the environment by removing harmful air pollutants and odors released during the manufacturing process.

- + *Dust Collectors, Baghouses, & Big Vents*
- + *Wet, Dry, & Electrostatic Scrubbers*
- + *Cyclone Separators*
- + *Regenerative Thermal Oxidizers (RTO)*



Industrial Ductwork

Whether you are looking for a replacement piece to an existing ductwork or a complete duct system, our skilled craftsmen fabricate high quality ductwork and custom build equipment to your exact specifications and requirements. Ductwork can be painted or galvanized to withstand corrosive and high temperature environments.

- + *Dust Collection*
- + *Exhaust Stacks & Hoods*
- + *Stainless Steel Ductwork*
- + *WESP Ductwork*
- + *Duct Dampers & Actuators*
- + *Expansion Joints*

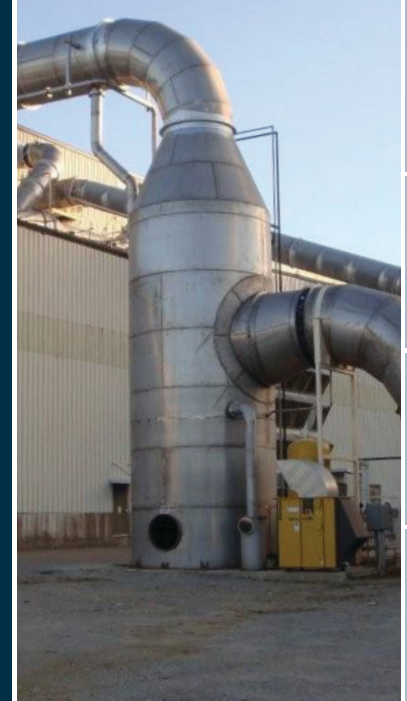

CONTROLS

ENERGY STORAGE

MOTORS

PUMPS

VALVES

COMPRESSORS

PNEUMATICS

SAWMILLS

METAL RECYCLING

TRANSIT & RAILROAD

WATER & WASTEWATER

DIMENSIONS & MOUNTING

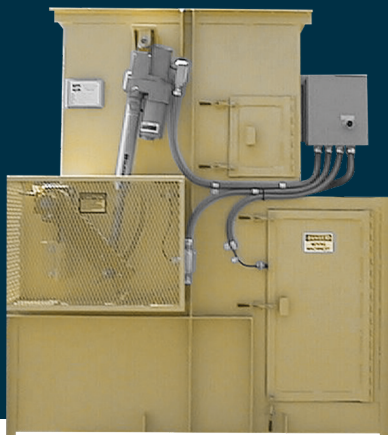

Sparkguard High Speed Abort Gate

FEATURES

- + Protect your pneumatic equipment and provide a safer environment.
- + Activated by spark detection equipment. Diverts hazardous sparks and fire.
- + Control panel with manual test and auto-reset buttons.
- + Standard sizes available to meet most pneumatic applications.

MODEL	FLOW RANGE (CFM)	WEIGHT
AG105	2,080 - 4,510	700 lbs
AG145	4,080 - 8,850	900 lbs
AG185	6,750 - 12,380	1200 lbs
AG245	12,000 - 22,000	1500 lbs
AG325	21,330 - 39,110	1900 lbs
AG405	33,330 - 61,110	2800 lbs
AG485	48,000 - 88,000	3300 lbs

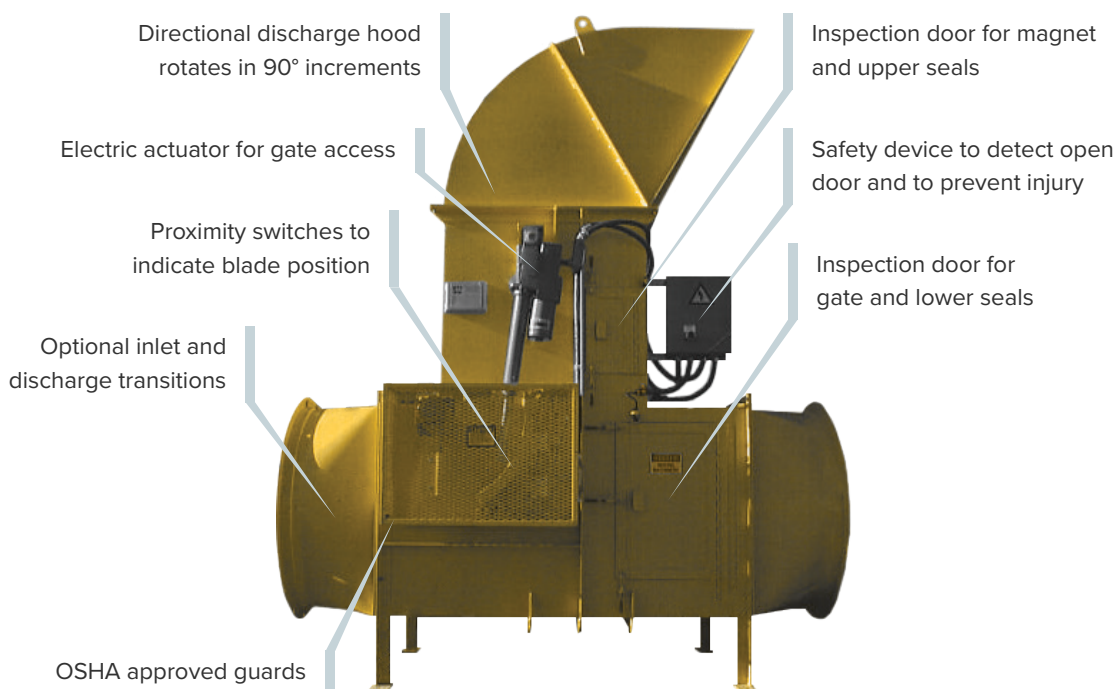



Backdraft Dampers

FEATURES

- + Replaceable aluminum explosion vent
- + Optional discharge transition
- + Rolled body reduces air turbulence and material build-up
- + Adjustable counterweight arm
- + Heavy gauge steel construction
- + Standard angle ring inlet connection

Typical installation is to locate the damper upstream of low-pressure pneumatic collectors (cyclone or filters). Our dampers are designed to automatically relieve back pressure under upset conditions. Backdraft dampers protect equipment and provide a safer environment. Our dampers also divert explosive pressure increased from plant facility. Standard size available up to 48-inch diameter.



SAWMILLS





Industrial Service Solutions



Crosby Sawmill Machines

Complete systems designed around your facility

Since 1933, Crosby Machines has been designing and manufacturing sturdy, dependable, and affordable sawmill equipment for the lumber industry utilizing today's technology with yesterday's experience. Our products are built in-house to ensure you receive high quality machines that perform. We keep a complete line of replacement parts in stock for each machine sold, ready to be shipped when you need them. With over 7,000 machines sold in over 27 states, makes us one of the largest providers of sawmill equipment in the world.



Edgers

Widths from 32" to 72"



Shop Online at
[CrosbyMachines.com](https://www.CrosbyMachines.com)

FEATURES

- + Top mounted arbor motor
- + Electric drive
- + Crosby special laser light bracket with roller chain connection
- + Ball bearing saw collars
- + Air popup straight edge
- + Hard chrome feed rolls
- + Electric over air networks for precision sets
- + Electric over hydraulic networks for precision sets and jog for grade hardwoods
- + Linear positioners, hydraulic motors, and computer controls also available
- + Top arbor or bottom arbor

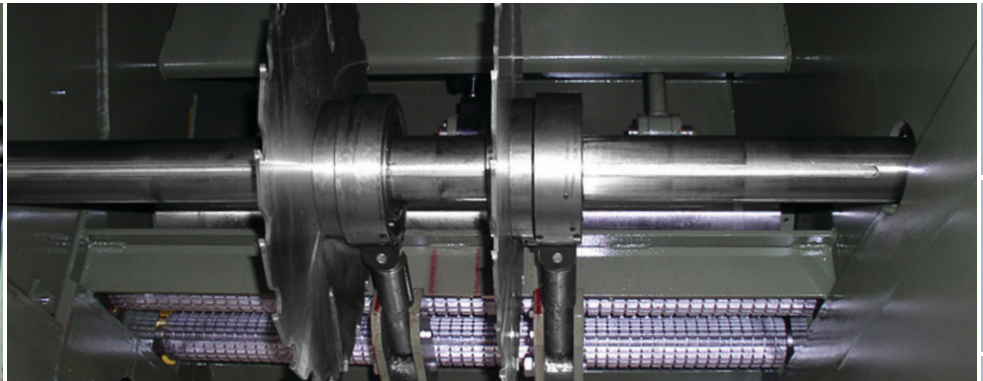
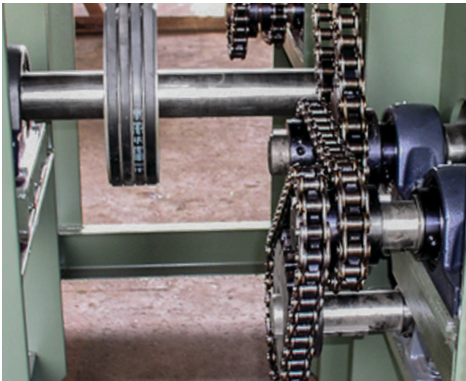

CONTROLS

ENERGY
STORAGE

MOTORS

PUMPS

VALVES

COMPRESSORS

PNEUMATICS

SAWMILLS

METAL
RECYCLING

TRANSIT &
RAILROAD

WATER &
WASTEWATER

DIMENSIONS
& MOUNTING



Gang Edgers

Widths from 30" to 72"



Shop Online at
CrosbyMachines.com

FEATURES

- + Thin top kerf arbor
- + Available with "Hands Off" remote controlled infeed tables
- + Heavy construction
- + Hard chromed feed rolls
- + Hardened spline sleeves or splined arbors
- + Positive custom designed feeds for smooth flow
- + Large puck babbitt guides
- + Miser Air/Oil/Water mist system
- + Guide milling machine
- + Babbitt mold
- + Many other options

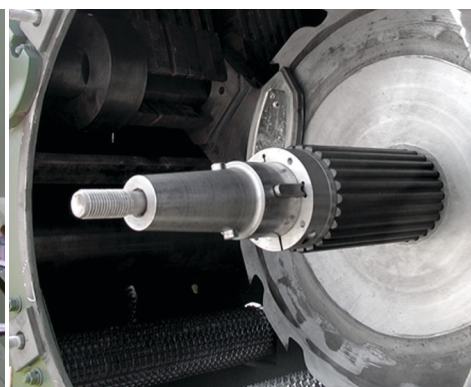
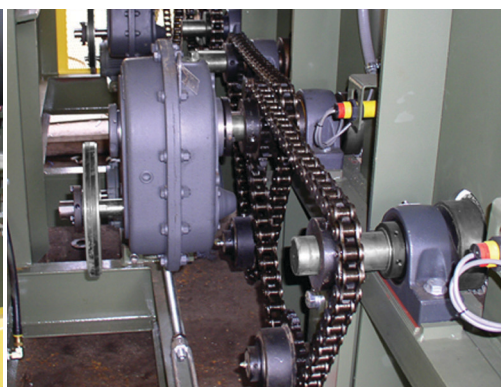
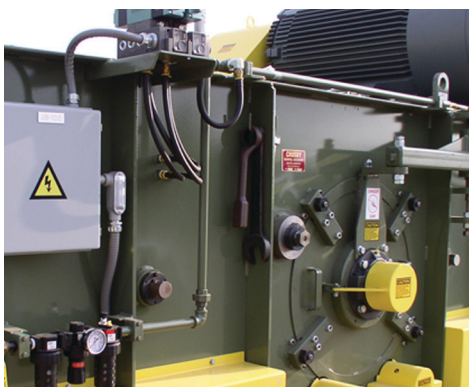



Optimized/Duty Edgers

Widths from 36" to 48" / 2 to 4 Saw

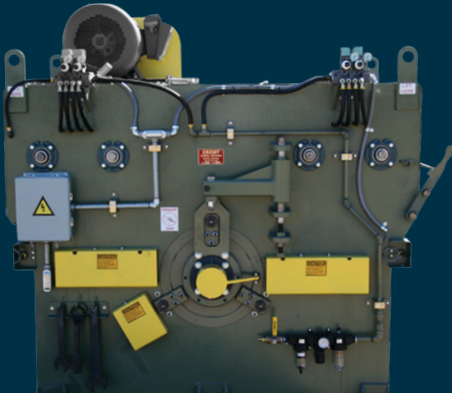

Shop Online at
CrosbyMachines.com

FEATURES

- + Top or bottom arbor
- + Compatible with most Transverse Optimizer Infeeders
- + Precision machined arbor
- + Low clearance ball bearing saw collars
- + Precision shifting arms
- + Linear bearing saw guide shaft
- + Linear positioner cylinders
- + Auto arbor lube

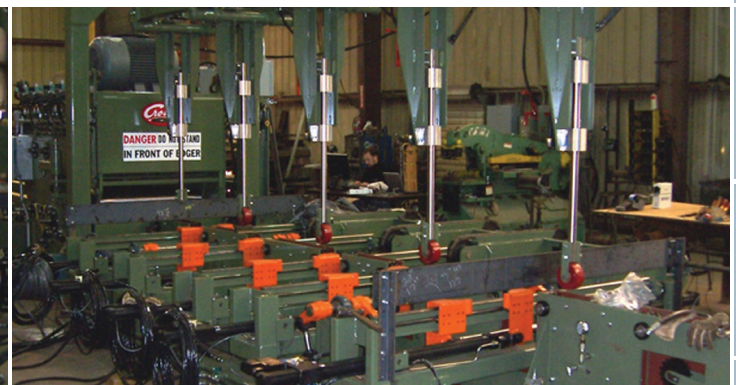
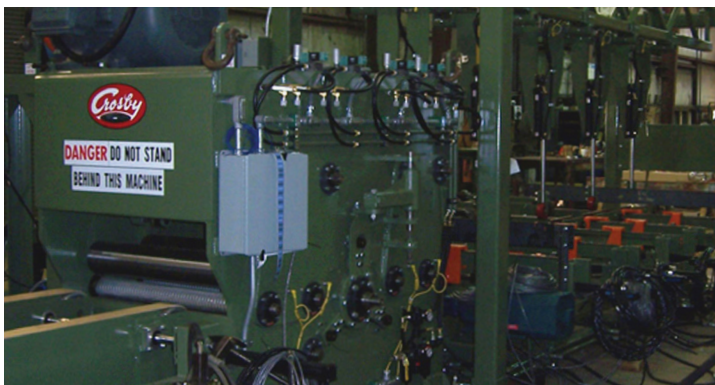

CONTROLS

ENERGY STORAGE

MOTORS

PUMPS

VALVES

COMPRESSORS

PNEUMATICS

SAWMILLS

METAL RECYCLING

TRANSIT & RAILROAD

WATER & WASTEWATER

DIMENSIONS & MOUNTING



Two Saw Trimmers

Trims 1" to 4" lumber



Shop Online at
CrosbyMachines.com

FEATURES

- + Lumber and cross-tie trimmers to trim up to 7.5" thick
- + Timber trimmers to trim up to 12" thick
- + Trimmers can start at 4', 6' and 8', trim to 16", 20", and 24" long
- + Saws move by electric over hydraulic sets. Trimmers can set in 1' or 2' increments with an 8' 6" length options
- + Trimmers offered with one saw stationary and one saw moving.
- + Trimmers can have both saws moving from their common center
- + Trimmers built with arbor motors and feed motors installed along with hydraulic power pack with motor
- + Option: Turnkey electrical includes starters, disconnect, fuses, and transformers for operator console
- + Option: Waste conveyors installed inside trimmer frames





Replacement Parts

For machines going back to the mid 1940s



Outfeed Belts



Outfeed Tables



Infeed Tables



Fabricated Saw Collars

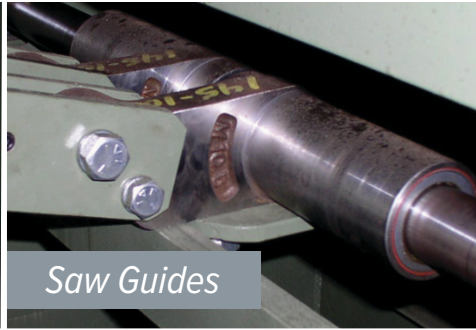

Saw Guides



Feed Rolls

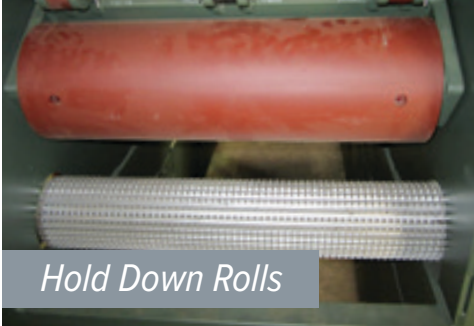

Hold Down Rolls

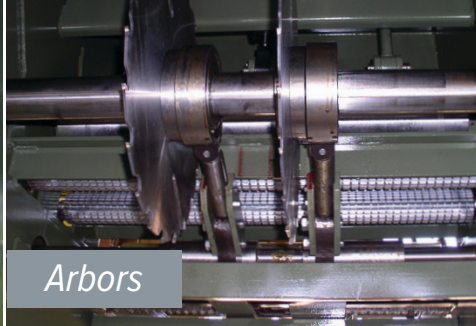

Arbors



Shop Online at
CrosbyMachines.com

CONTROLS

ENERGY STORAGE

MOTORS

PUMPS

VALVES

COMPRESSORS

PNEUMATICS

SAWMILLS

METAL RECYCLING

TRANSIT & RAILROAD

WATER & WASTEWATER

DIMENSIONS & MOUNTING

METAL RECYCLING





Industrial Service Solutions

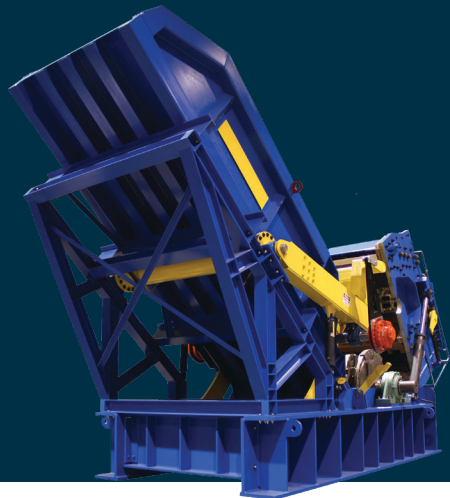

Stationary Shredders

Process 40 to 300 tons/hr

INPUT MATERIAL

- + Aluminum Cans
- + Loose & Mixed Aluminum Scrap
- + Aluminum Profiles
- + Aluminum Pipes
- + Aluminum Sumps
- + Aluminum Scrap Bales
- + Aluminum Engine Blocks
- + Metal Cans & Light Scrap
- + Slightly Pressed, Sheared, & Entire Metal Scrap Bales
- + Car Parts
- + Sheared, Flattened, & Entire Cars
- + Small, Medium, & Large White Goods/Appliances
- + CDW & Concrete

MODEL	HP	WIDTH	ROTOR	CAPACITY
7090	1,000 - 4,000	90"	70"	40 - 100 tons/hr
80108	2,000 - 5,000	108"	80"	60 - 120 tons/hr
98104	4,000 - 6,000	104"	98"	120 - 200 tons/hr
120118	6,000 - 9,000	118"	120"	200 - 300 tons/hr

FEATURES

- + Can be driven by AC or DC motors
- + Averages 40 tons/hr at 1,000 HP and up to 300 tons/hr at 9,000 HP
- + Heavy duty feed chute is constructed of heavy beams and torque tube to prevent flexing
- + Feed roll cover prevents material from flipping onto the shredder housing, which prevents downtime and maintains a safe, clean environment
- + Haggblunds feed roll drive is the standard for longevity and ease of maintenance
- + Built with 4" side walls and completely lined
- + Same thickness of grates and liners of larger shredders
- + Proven spyder style rotor and disc rotors with heavy duty lubricated bearings and housing

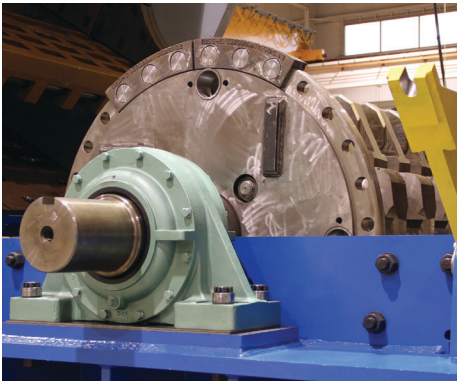

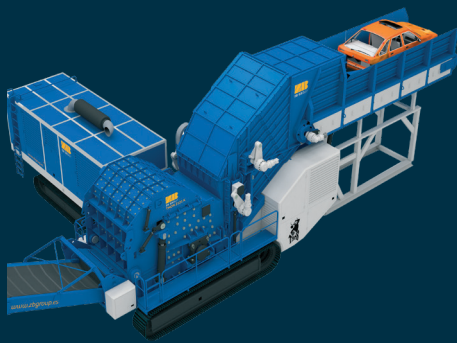

Mobile Hammer Mills

Process 11 to 40 tons/hr

INPUT MATERIAL

- + Aluminum Cans
- + Loose & Mixed Aluminum Scrap
- + Aluminum Profiles
- + Aluminum Pipes
- + Aluminum Sumps
- + Aluminum Scrap Bales
- + Aluminum Engine Blocks
- + Metal Cans & Light Scrap
- + Slightly Pressed, Sheared, & Entire Metal Scrap Bales
- + Car Parts
- + Sheared, Flattened, & Entire Cars
- + Small, Medium, & Large White Goods/Appliances
- + CDW & Concrete

MODEL	bHP	SHREDDER			FEED	DISCHARGE	CAPACITY
		WIDTH	ROTOR	HAMMER			
1521K	760	60"	82"	230 lbs	60" x 186"	40" x 216"	11 - 16 tons/hr
1721K	220	67"	82"	230 lbs	67" x 276"	47" x 216"	16 - 27 tons/hr
2121KC	1,200	82"	82"	225 lbs	83" x 216"	63" x 216"	16 - 33 tons/hr
2121K	220	83"	82"	230 lbs	83" x 276"	63" x 216"	22 - 38 tons/hr
8080K	220	83"	80"	230 lbs	83" x 276"	63" x 216"	25 - 40 tons/hr

FEATURES

- + Final product density upgrade and volume reduction
- + Wide range of materials to process
- + Designed to minimize wear and maintenance costs
- + Optimized footprint and mounted on track system for high mobility
- + Reduced assembly time for low assembly cost
- + Top quality components and vendor list provides high residual value
- + Process monitoring and optimization service



CONTROLS

ENERGY STORAGE

MOTORS

PUMPS

VALVES

COMPRESSORS

PNEUMATICS

SAWMILLS

METAL RECYCLING

TRANSIT & RAILROAD

WATER & WASTEWATER

DIMENSIONS & MOUNTING



TAURUS

Shear Balers

Kappa, Mille, Rapid, & Giant Series

INPUT MATERIAL

- + Scrap Bale
- + ELV Cars
- + Collection & Heavy Scrap
- + Demolition Sheared

MODEL	HP	SHEAR FORCE	BOX LENGTH	CYL. PER WING	COMP. MAX FORCE	MAIN CYL. FORCE	BALE SIZE
K662	250	600 tons	240"	2	300 tons	150 tons	34" x 23"
K772	250	700 tons	283"	2	300 tons	150 tons	34" x 23"
K872	350	800 tons	283"	2	350 tons	150 tons	34" x 23"
K973	350	900 tons	283"	3	450 tons	150 tons	34" x 23"
ACH107	350	1,000 tons	283"	3	450 tons	150 tons	34" x 23"
ACH117	350	1,100 tons	283"	3	450 tons	150 tons	34" x 23"
RH117	450	1,100 tons	283"	3	450 tons	150 tons	39" x 27"
RH137	450	1,300 tons	283"	3	450 tons	150 tons	39" x 27"
RS117	450	1,100 tons	283"	3	450 tons	150 tons	39" x 27"
RS137	450	1,300 tons	283"	3	450 tons	150 tons	39" x 27"
ASG148	-	1,400 tons	326"	3	600 tons	180 tons	43" x 31"
ASG158	-	1,500 tons	326"	3	600 tons	180 tons	43" x 31"

FEATURES

- + Robust machines suitable for high density compacting and shearing of large quantities of mixed and bulky scrap from collection or demolition
- + Can be loaded from both sides and managed by a single operator
- + Hydraulic power system combines low consumption with high performance to allow higher cutting speeds
- + Box floor and lids are made of high-strength and wear resistant steel
- + Equipped with patented oscillating wing compression system with over stroke on both lids to facilitate scrap compression and reduce frictional wear
- + Single monolithic body makes it easy to install and reposition
- + Mounted on a welded steel support structure equipped with original VDP self-leveling and anti-vibration plate system



TAURUS

Baler Loggers

Biblo & Mizar Series



INPUT MATERIAL

- + Light Scrap
- + Aluminum Bars, Plates & Sheets
- + ELV Cars
- + White Household appliances
- + Rod, Sheet, & Collected Scrap

MODEL	HP	BOX LENGTH	CYL. PER WING	COMP. MAX FORCE	MAIN CYL. FORCE	BALE SIZE
BB44	75	106"	1	100 tons	160 tons	15" x 15"
BB55	75	157"	2	165 tons	160 tons	19" x 19"
BB66	75	196"	2	200 tons	160 tons	23" x 23"
M52B	145	196"	2	160 tons	-	34" x 23"
M52D	145	196"	2	160 tons	-	34" x 23"
M62B	145	240"	2	160 tons	-	34" x 23"
M62D	145	240"	2	160 tons	-	34" x 23"

FEATURES

- + Single ridged squeeze box constructed of Hardox wear resistant steel
- + Single oscillating lid is hinged at the center and provides two stage compression, which reduces pre-compression cycle time and generates an offset square bale
- + The offset bale reduces wear and tear on the squeeze box and minimizes vibrations during compression cycle
- + Hydraulic aggregate and electrical components are located safely in the rear
- + Fixed on single supporting framework eliminates need for expensive foundations
- + Quick and easy to transport and can be equipped with a roll on/off lifting hook

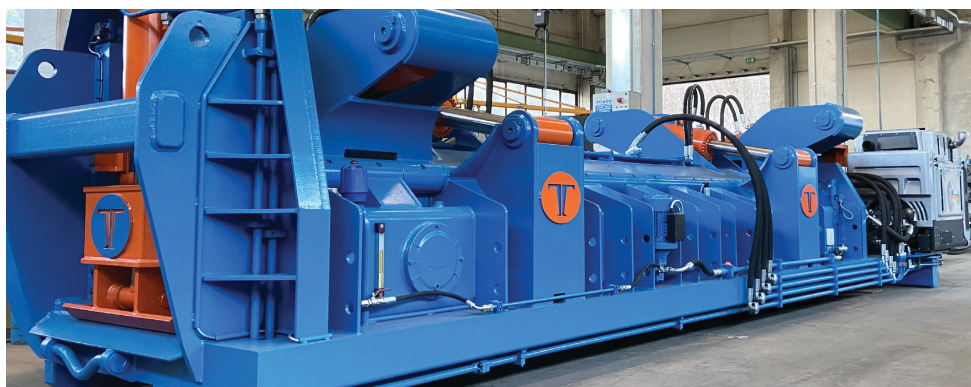



TAURUS

Rotary Shears

Delta Series

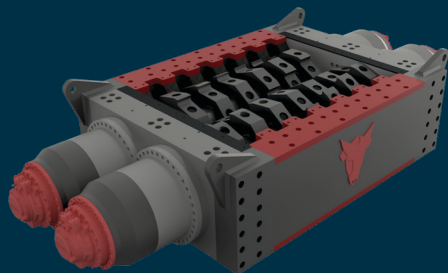

INPUT MATERIAL

- + Industrial & General Waste
- + Metal Containers
- + Light, Collection, & Heavy Scrap
- + ELV Cars
- + Pantographed Sheets
- + Household appliances
- + Packaging, Pallets, & Crates
- + Electric Cabinets
- + Telephones & Coin Acceptors
- + Archives, Tires, & Copper Cables

MODEL	FEEDING CHAMBER	BLADES THICKNESS	WEIGHT	OUTPUT
D82	86" x 63"	7-7/8"	50 tons	20 tons/hr
D94	86" x 67"	7-7/8"	60 tons	30 tons/hr
D15	86" x 78"	7-7/8"	75 tons	50 tons/hr
D16	86" x 78"	7-7/8"	80 tons	60 tons/hr

FEATURES

- + Low speed and high torque counter rotating blades
- + Includes steelwork platform, loading hopper, and 20" container



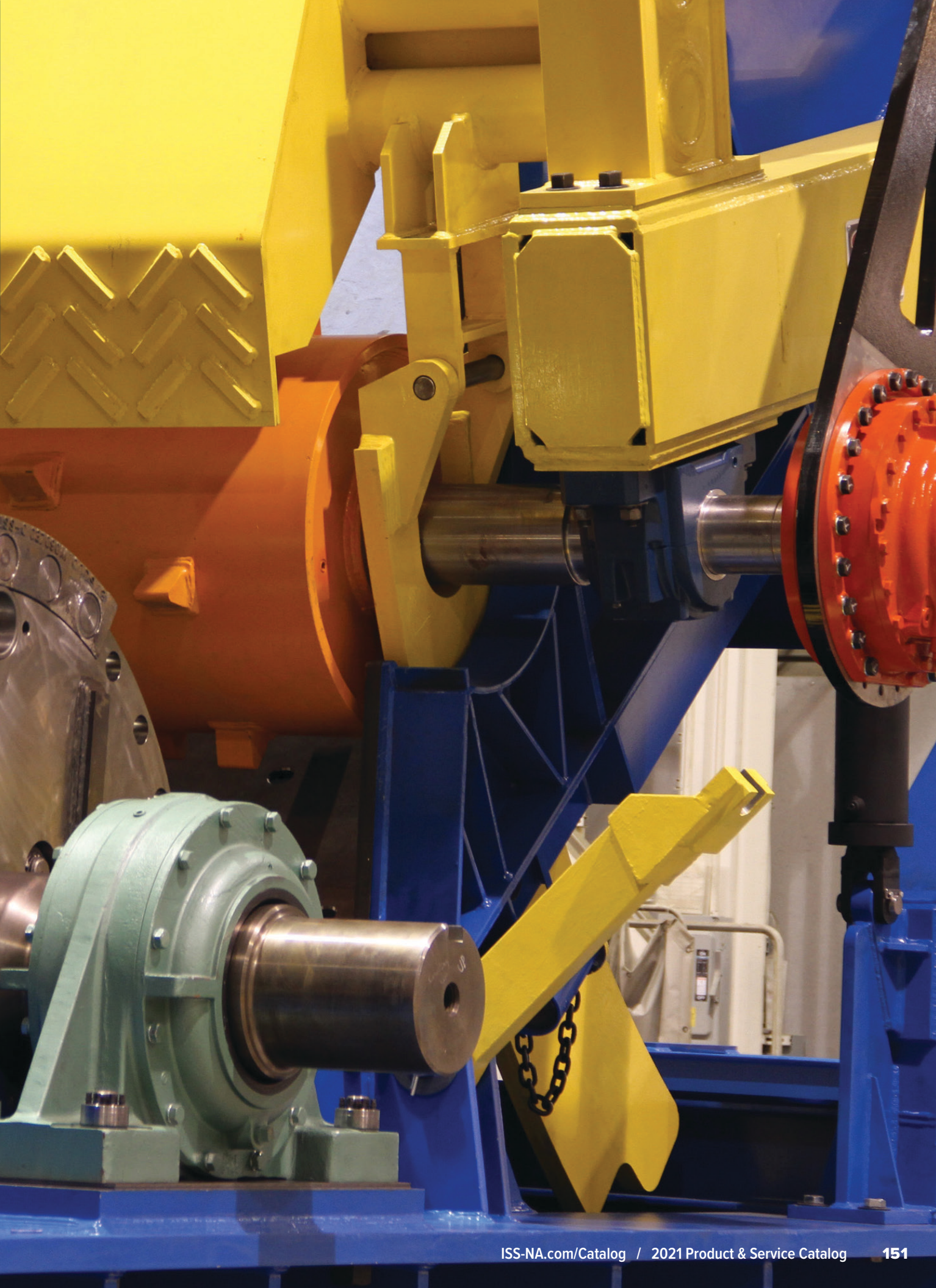

CONTROLS

ENERGY STORAGE

MOTORS

PUMPS

VALVES

COMPRESSORS

PNEUMATICS

SAWMILLS

METAL RECYCLING

TRANSIT & RAILROAD

WATER & WASTEWATER

DIMENSIONS & MOUNTING

TRANSIT & RAILROAD





CONTROLS

ENERGY STORAGE

MOTORS

PUMPS

VALVES

COMPRESSORS

PNEUMATICS

SAWMILLS

METAL RECYCLING

TRANSIT & RAILROAD

WATER & WASTEWATER

DIMENSIONS & MOUNTING

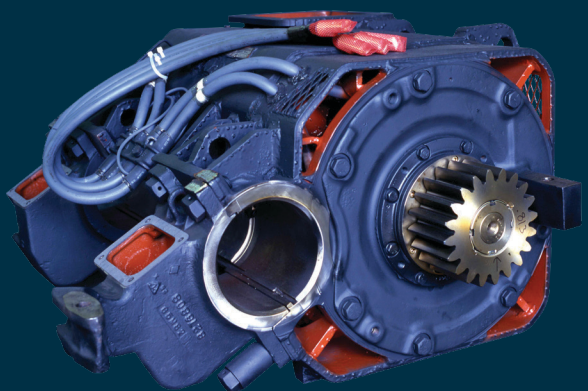

Repairs & Overhauls

Our high-capacity ISO 9001:2015 certified shops are fully equipped to service and repair locomotive, transit and light rail, hybrid bus, and other rotating equipment applications to your exact specifications on time and within budget. Whether it's a complete overhaul or a single part, our technicians have the technical expertise and tailored processes to deliver equipment better than new, with tighter tolerances and enhanced efficiency. For emergency repairs, our shops are available around-the-clock to machine and fabricate unavailable or obsolete parts.

- + AC & DC Traction Motors
- + Hybrid Bus Motor Stators
- + Main & Auxillary Generators
- + Alternators
- + Air Compressors
- + Gearboxes
- + Pumps
- + Smoothing Reactors
- + Control Panels
- + Engine Blowers
- + Cooling Fans
- + Refrigerators
- + Step Heaters
- + Track Brakes

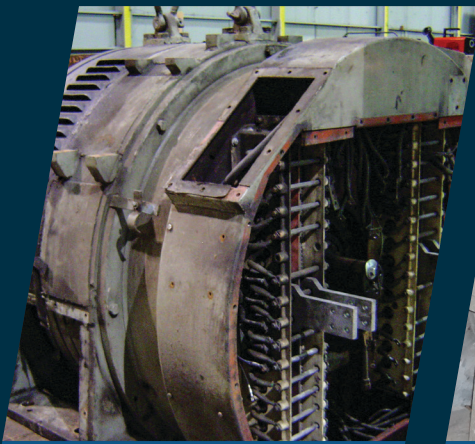

Before

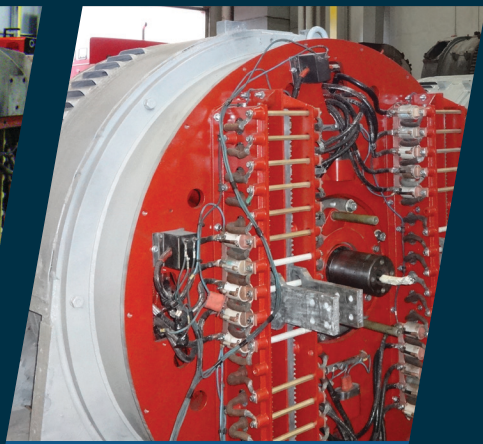

After

Rewinding Services

Industrial Service Solutions' qualified and certified technicians are experienced in rewinding, reinsulating, and repairing equipment for railroad and transit applications. Our vacuum pressure impregnation (VPI) process tanks are capable of handling up to 96-inch diameter equipment and multiple resins. We provide customized in-house rewinding designs to mitigate electrical, thermal, mechanical, and environments stress of the following equipment.

- + AC Stators
- + AC Rotors
- + DC Armatures
- + DC Coils
- + Smoothing Reactors
- + Hermetic Motors
- + Bus Drive Unit Motors
- + Generators
- + Alternators
- + Transformers
- + Shunts

HVAC Repairs & Testing

Our EPA certified technicians specialize in the repair, overhaul, testing, maintenance, reclamation, manufacturing, and inspection of HVAC and refrigeration units for the railroad and transit industry. We are the leading provider of field refrigerant retrofits and utilize climate control rooms to verify performance meets or exceeds specifications. With our state-of-the-art testing laboratory, we have the capability to perform qualification, functional, and conditioned tests on any HVAC system.



HVAC Climate Room
<130°F / 85% Humid.



Qualification &
Pressure Testing



CONTROLS

ENERGY STORAGE

MOTORS

PUMPS

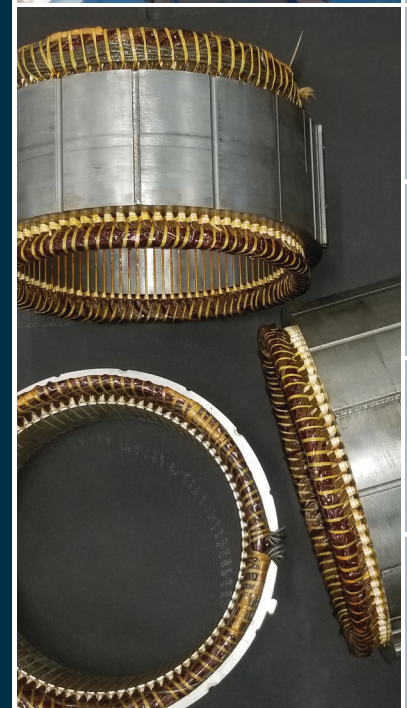

VALVES

COMPRESSORS

PNEUMATICS

SAWMILLS



METAL RECYCLING

TRANSIT & RAILROAD

WATER & WASTEWATER

DIMENSIONS & MOUNTING

WATER & WASTEWATER





Industrial Service Solutions

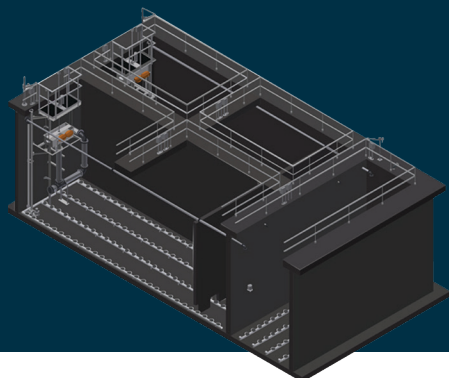
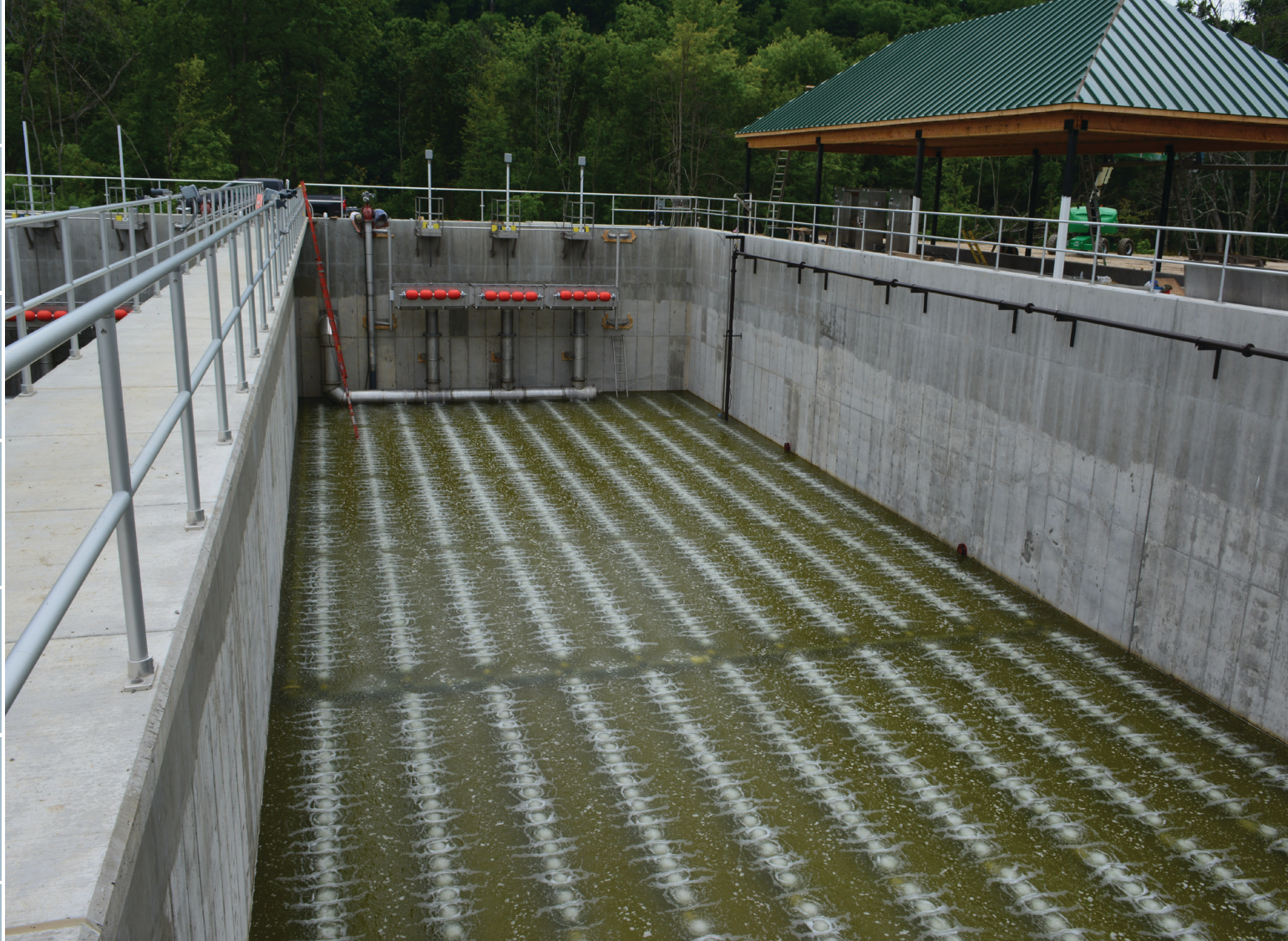

Sequence Batch Reactors (SBR)

Clean water made easy

APPLICATIONS

- + Municipal / Sanitary
- + Industrial Wastewater
- + Food Processing Wastewater

FEATURES

- + One tank for all cycles/steps: Fill, React, Settle, Decant, and Idle
- + Complete effluent treatment, including nutrient removal
- + Tolerates variable hydraulic and organic loading
- + Offered in both continuous and batch operating modes
- + Precisely controlled positively driven jack screw decanter
- + Stainless steel decanter with float activated scum prevention door
- + PLC (Programmable Logic Controller)

The Sequence Batch Reactor (SBR) is an aeration process for the complete treatment of municipal, industrial, and agricultural wastewaters. The process takes place in a single tank and is capable of removing BOD, ammonia, suspended solids, and nutrients. Sewage is treated in a series of four distinct sequences. An initial fill cycle allows raw sewage to enter the tank. An aeration cycle then begins converting nonvolatile sludge and oxidized ammonia to nitrate. After the aeration cycle is complete, a precipitation phase allows the sludge to settle under quiescent conditions. Treated effluent is then decanted from the tank during a decant phase, after which, the cycle is repeated. A SBR will typically consist of two or more tanks, allowing one tank to discharge treated effluent while another tank is available to accept sewage flow. The process contains minimal basin equipment ensuring affordable capital cost. The simple design and ease of operation ensures reduced maintenance and operation expenses.

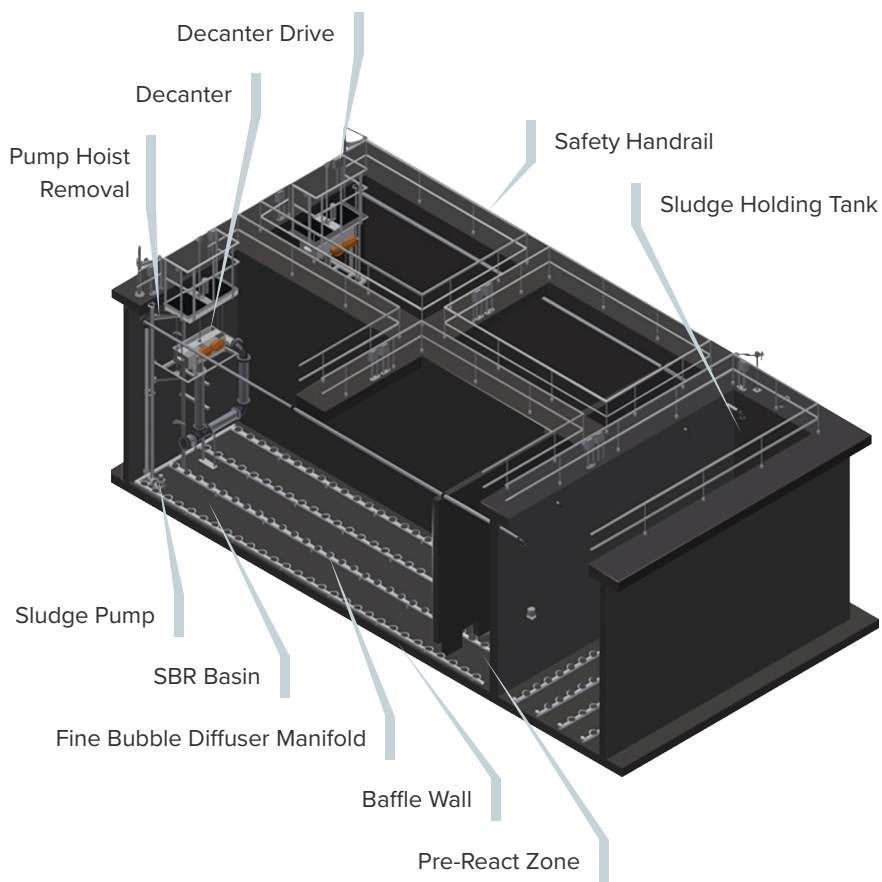

CONTROLS
ENERGY STORAGE
MOTORS
PUMPS
VALVES
COMPRESSORS
PNEUMATICS
SAWMILLS
METAL RECYCLING
TRANSIT & RAILROAD
WATER & WASTEWATER
DIMENSIONS & MOUNTING

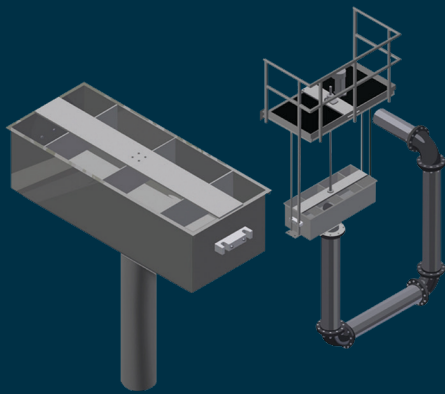

SBR Decanters

Vertically driven & highly reliable

FEATURES

- + Visible decanter weir from basin walkway allows operator to maintain effluent quality visual
- + Decants from top and moves downward preventing disruption of solids and withdraws only clear water
- + All maintenance performed from safety platform

APPLICATIONS

- + Municipal / Sanitary
- + Industrial Wastewater
- + Food Processing Wastewater

The heart of every Sequence Batch Reactor (SBR) system is the decanter. The decanter is responsible for removing clarified effluent from the basin during the decant phase of the sequence cycle. The decanter is installed on the basin wall supported by a stainless-steel fabrication, grating and railing provides a stable platform for maintenance and plant operators. The decanter is lowered and raised using an electro-mechanical jack screw actuator. The actuator moves the decanter between two set point elevations from the “park” position to the bottom water level (BWL). The decanter parks above top water level during the aeration and settling phases of the cycle, thereby eliminating any possibility of solids carryover during these periods. The decanter operation and speed is controlled through use of a variable frequency drive (VFD). As a result, the decanter discharge rate is constant from the time the decanter enters the water to the time it reaches the BWL. Effluent volume per linear foot of weir is controlled and constant versus gravity style decant systems. At “park” position, the decanter provides fail-safe overflow protection in the event of a power failure. Settled supernatant flow raise the scum gate floats allowing water to flow under the scum baffle and over the decanter weir free of floatable scum under power failure or storm mode.

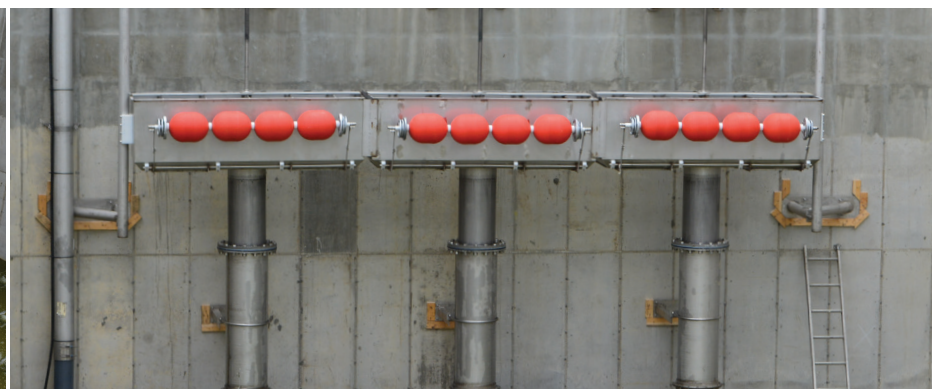
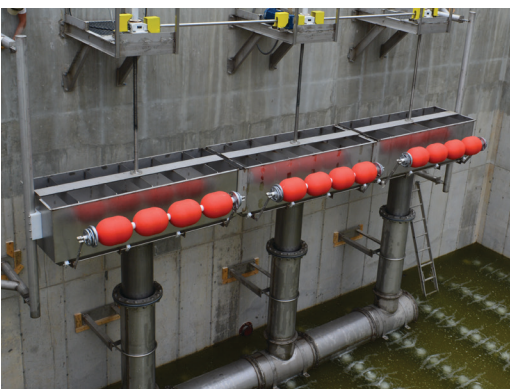

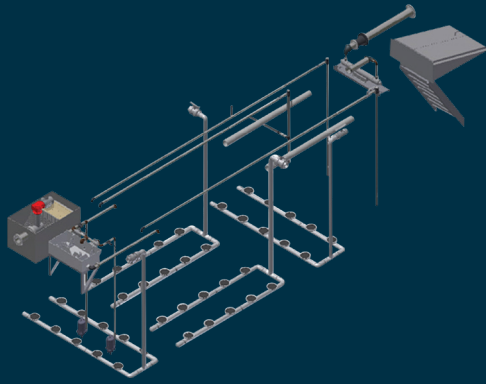

Extended Aeration

Engineered to optimize performance

FEATURES

- + Simple low cost design
- + Minimal sludge production
- + Constructed from concrete and epoxy
- + Coated carbon steel for long lasting corrosion-free service
- + Air-operated lift pumps
- + Flexible process that can treat a wide range of wastewater
- + Can be designed with de-nitrification

APPLICATIONS

- + Municipal / Sanitary
- + Industrial Wastewater
- + Food Processing Wastewater

The extended aeration wastewater treatment plant is based on a time-proven, conservative process design, and engineered to optimize performance. Extended Aeration wastewater treatment plants are one of the simplest, economical and most versatile methods available to treat sanitary, industrial or agricultural wastewater. Treatment plants meet or exceed effluent parameters for most wastewater applications and are economical to install and operate.

Extended Aeration treatment plants provide the proper environment, sufficient oxygen, and other elements which allow the bacteria to consume the organic matter to live and multiply within the treatment plant. In this way the aerobic bacteria and microbes decompose the sewage and waste to a stable form free of odor and costly maintenance. Each plant consists of two major compartments, the main aeration chamber and a clarifier or settling tank. After initial screening, the wastewater enters the main aeration tank, which has a retention time of approximately 24 hours. Here, natural bacteria feed on the organic fraction of the sewage and reduce Biochemical Oxygen Demand (BOD) concentrations. The partially treated sewage then flows to the final settling tank for clarification prior to discharge. The effluent may be filtered and disinfected, depending on discharge permit requirements.

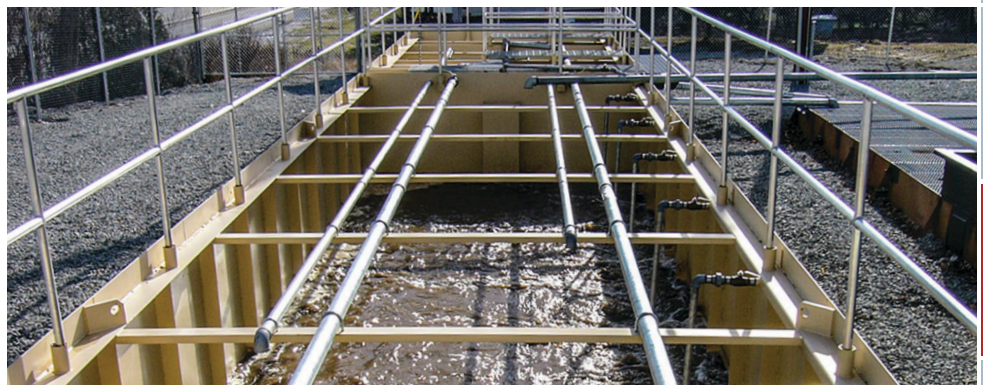

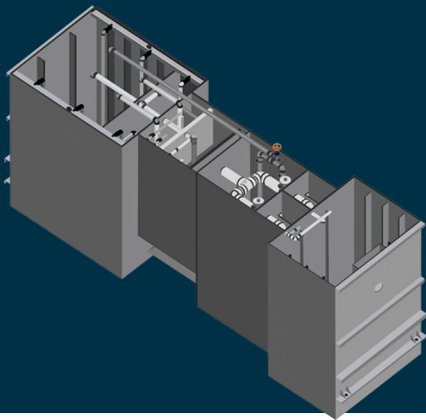

Denitrification & Tertiary Filtration Systems

Time proven: tried & tested

FEATURES

- + Enhanced carbon feed source control and monitoring
- + Wide selection of level controls
- + Highest quality grade of media
- + Backwash and air scouring systems & control optimization
- + Simple operator controls and optional system integration into existing plant control panel
- + Operator training and field service support

Our denitrification and tertiary filtration systems provide a time proven process for the reduction of nutrients as well as suspended solids from the effluent of wastewater treatment plants. The process accepts secondary effluent by gravity or lift station to a distribution box with automatic control valves. The distribution box and control valves direct water to each filter cell in proper sequence. The anoxic biological process and conversion of nitrate-n to elemental nitrogen gas takes place on a fixed film of bacteria residing on and within a coarse mono media. The down flow design of the “De-nite” filter effectively reduces suspended solids and phosphorus by addition of alum and mechanical filtration through the bed. The anoxic bacteria require a carbon source as supplement which may include methanol, acetic acid and other proprietary chemistry.

APPLICATIONS

- + Municipal / Sanitary
- + Industrial Wastewater
- + Food Processing Wastewater



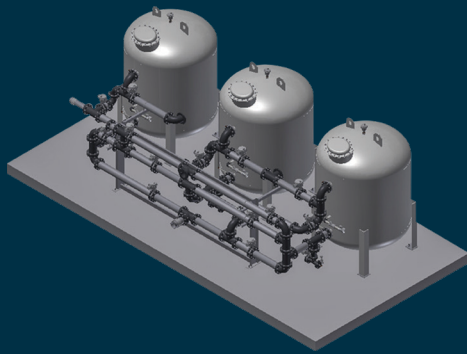

Iron & Manganese Filters

Higher capacity & higher volume

FEATURES

- + Tanks constructed from FRP and carbon steel per ASME Section VIII
- + Stainless steel distribution and collection manifolds
- + Stainless steel air scour piping
- + Pneumatic or electric valves
- + Carbon steel face piping, cement lined rubber, HDPE or stainless steel as option
- + NEMA 4 painted carbon or stainless steel control panel with PLC and HMI touchscreen

Iron and manganese filters are engineered and designed to meet our customer's specific requirements. The process utilizes Greensand Plus®, which is superior to conventional glauconite manganese greensand and synthetic catalyst. Greensand Plus® eliminates the need for potassium permanganate regeneration and may be regenerated with chlorine, hypochlorite or any strong oxidant. It has significantly higher capacity, which results in higher volume throughput, reduced backwash cycles, and volume of waste to drain. Systems come complete with all face piping, blowers, automatic valves, and controls for proper operation.

APPLICATIONS

- + Municipal / Sanitary
- + Industrial Wastewater
- + Food Processing Wastewater



Single-Phase TEFC Rolled Steel Motors

Foot Mount / 48 to 215T Frame

48-145T

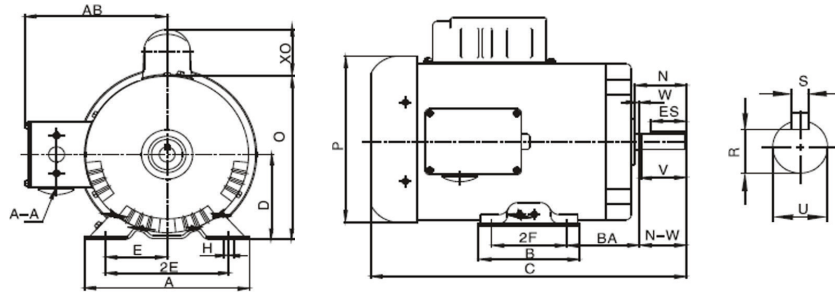

184T-215T

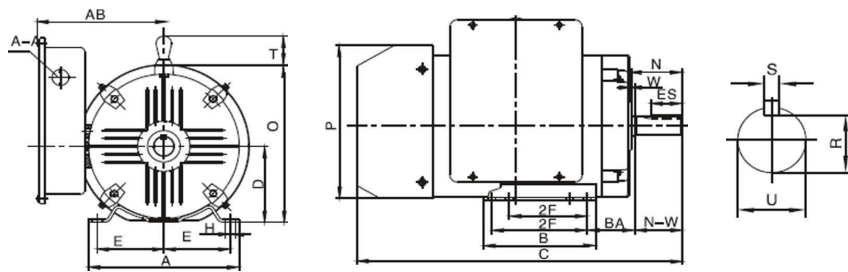

FRAME	MAX A	MAX B	C	D	E	2F	H	N	N-W	O	P	R	S	U	MIN V	MIN AA	AB	BA	MIN ES
48	6	3.8	10	3	2.12	2.75	0.34	1.62	1.5	5.83	5.66	0.453	-	0.5	1.125	1/2	5.3	2.5	-
56	6.5	4.2	12.7	3.5	2.44	3	0.34	2.4	1.88	6.7	7.08	0.517	0.188	0.625	1.5	1/2	5.6	2.75	1.41
143T	7	6.18	14.6	3.5	2.75	4	0.34	2.46	2.25	6.7	7.08	0.771	0.188	0.875	2	3/4	5.6	2.25	1.41
145T						5													
182T	8.5	6.5	18.8	4.5	3.75	4.5	0.41	2.98	2.75	9.25	9.25	0.986	0.25	1.125	2.5	3/4	7.2	2.75	1.78
184T						5.5													
213T	9.5	8	20.5	5.25	4.25	5.5	0.41	3.66	3.38	9.84	10	1.201	0.312	1.375	3.12	1	7.5	3.5	2.41
215T						7													

CONTROLS
ENERGY STORAGE
MOTORS
PUMPS
VALVES
COMPRESSORS
PNEUMATICS
SAWMILLS
METAL RECYCLING
TRANSIT & RAILROAD
WATER & WASTEWATER
DIMENSIONS & MOUNTING

Single-Phase TEFC Rolled Steel Motors

C-Face / 48C to 215TC Frame

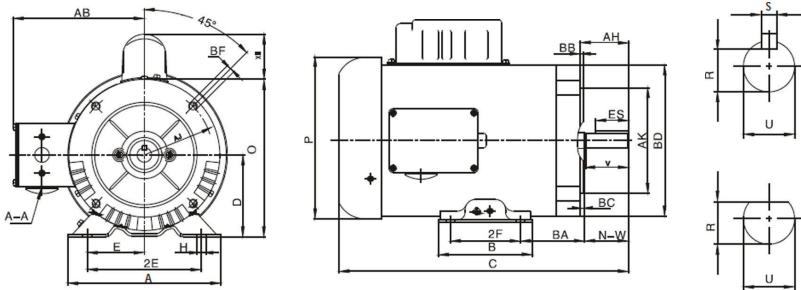

FRAME	A	MAX B	C	D	E	2F	N-W	O	P	R	S	U	MIN AA	AB	AH	AJ	AK	BA	MAX BB	BC	MAX BD	BF	MIN ES
48C	6	3.8	10	3	2.12	2.75	1.5	5.83	5.66	0.453	-	0.5	1/2	5.3	1.69	3.75	3	2.5	0.16	-0.19	5.625	1/4-20	-
56C	6.5	4.2	12.7	3.5	2.44	3	1.88	6.7	7.08	0.517	0.188	0.625	1/2	5.6	2.06	5.875	4.5	2.75	0.16	-0.19	6.5	3/8-16	1.41
143TC	7	6.18	14.6	3.5	2.75	4	2.25	6.7	7.08	0.771	0.188	0.875	3/4	5.6	2.12	5.875	4.5	2.75	0.16	0.12	6.5	1/2-13	1.41
145TC						5																	
182TC	8.5	6.5	18.8	4.5	3.75	4.5	2.75	9.25	9.25	0.986	0.25	1.125	3/4	7.2	2.62	7.25	8.5	3.5	0.25	0.12	9	1/2-13	1.78
184TC						5.5																	
213TC	9.5	8	20.5	5.25	4.25	5.5	3.38	9.84	10	1.201	0.312	1.375	1	7.5	3.12	7.25	8.5	4.25	0.25	0.25	9	1/2-13	2.41
215TC						7																	

CONTROLS

ENERGY STORAGE

MOTORS

PUMPS

VALVES

COMPRESSORS

PNEUMATICS

SAWMILLS

METAL RECYCLING

TRANSIT & RAILROAD

WATER & WASTEWATER

DIMENSIONS & MOUNTING

Single-Phase ODP Rolled Steel Motors

Foot Mount / 48 to 215T Frame

48-56

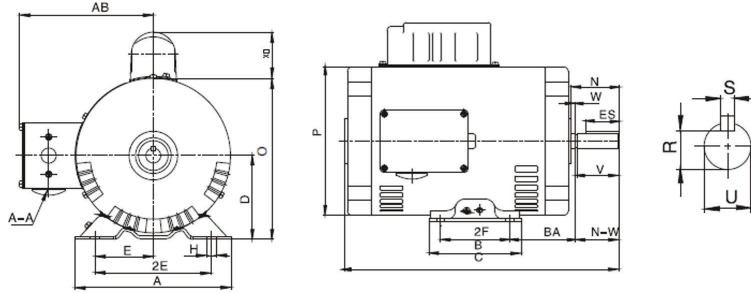

143T-215T

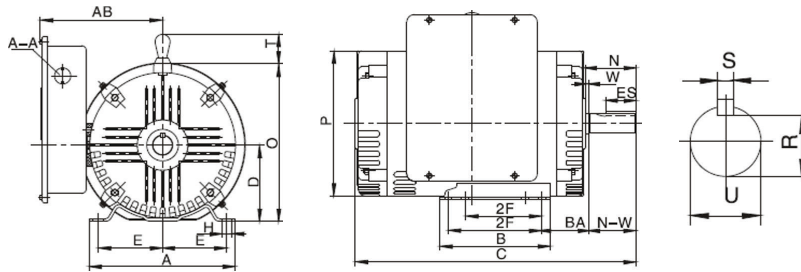

FRAME	MAX A	MAX B	C	D	E	2F	H	N	N-W	O	P	R	S	U	MIN V	MIN AA	AB	BA	MIN ES
48	6	3.8	10	3	2.12	2.75	0.34	1.62	1.5	5.83	5.66	0.453	-	0.5	1.125	1/2	5.3	2.5	-
56	6.5	4.2	11.4	3.5	2.44	3	0.34	2.4	1.88	6.7	6.45	0.517	0.188	0.625	1.5	1/2	5.6	2.75	1.41
143T	7	6.18	13.3	3.5	2.75	4	0.34	2.46	2.25	6.7	6.45	0.771	0.188	0.875	2	3/4	5.6	2.25	1.41
145T						5													
182T	8.5	6.5	16.5	4.5	3.75	4.5	0.41	2.98	2.75	9.25	8.5	0.986	0.25	1.125	2.5	3/4	7.2	2.75	1.78
184T						5.5													
213T	9.5	8	18	5.25	4.25	5.5	0.41	3.66	3.38	9.84	9	1.201	0.312	1.375	3.12	1	7.5	3.5	2.41
215T						7													

Single-Phase ODP Rolled Steel Motors

C-Face / 48C to 215TC Frame

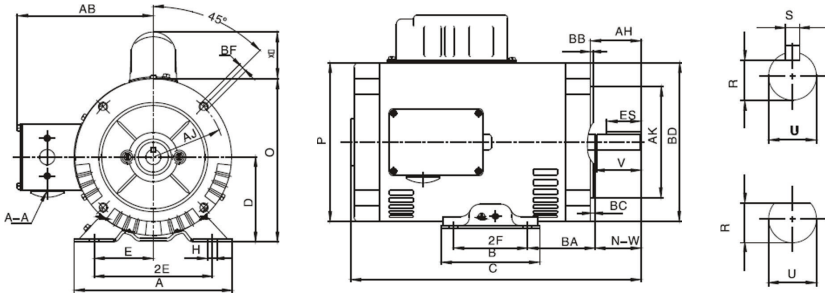

FRAME	A	MAX B	C	D	E	2F	N-W	O	P	R	S	U	MIN AA	AB	AH	AJ	AK	BA	MAX BB	BC	MAX BD	BF	MIN ES
48C	6	3.8	10	3	2.12	2.75	1.5	5.83	5.66	0.453	-	0.5	1/2	5.3	1.69	3.75	3	2.5	0.16	-0.19	5.625	1/4-20	-
56C	6.5	4.2	11.4	3.5	2.44	3	1.88	6.7	6.45	0.517	0.188	0.625	1/2	5.6	2.06	5.875	4.5	2.75	0.16	-0.19	6.5	3/8-16	1.41
143TC	7	6.18	13.3	3.5	2.75	4	2.25	6.7	6.45	0.771	0.188	0.875	3/4	5.6	2.12	5.875	4.5	2.75	0.16	0.12	6.5	1/2-13	1.41
145TC						5																	
182TC	8.5	6.5	16.5	4.5	3.75	4.5	2.75	9.25	8.5	0.986	0.25	1.125	3/4	7.2	2.62	7.25	8.5	3.5	0.25	0.12	9	1/2-13	1.78
184TC						5.5																	
213TC	9.5	8	18	5.25	4.25	5.5	3.38	9.84	9	1.201	0.312	1.375	1	7.5	3.12	7.25	8.5	4.25	0.25	0.25	9	1/2-13	2.41
215TC						7																	

CONTROLS

ENERGY STORAGE

MOTORS

PUMPS

VALVES

COMPRESSORS

PNEUMATICS

SAWMILLS

METAL RECYCLING

TRANSIT & RAILROAD

WATER & WASTEWATER

DIMENSIONS & MOUNTING

Three-Phase TEFC Rolled Steel Motors

Foot Mount / 48 to 215T Frame

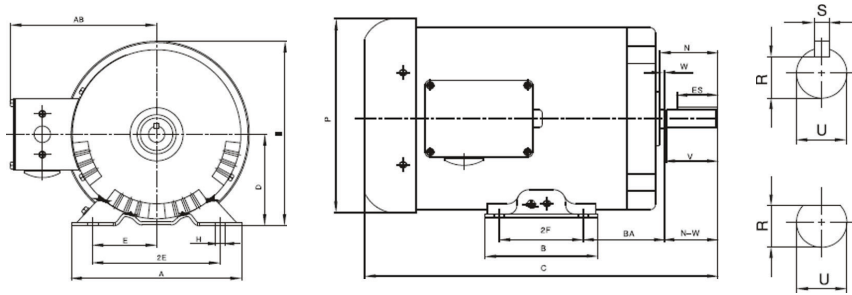

FRAME	MAX A	MAX B	C	D	E	2F	H	N	N-W	O	P	R	S	U	MIN V	MIN AA	AB	BA	MIN ES
48	6	3.8	10	3	2.2	2.75	0.34	1.62	1.5	5.83	5.66	0.453	-	0.5	1.25	1/2	5.3	2.5	-
56	6.5	4.2	12.7	3.5	2.44	3	0.34	2.4	1.88	6.7	7.08	0.517	0.188	0.625	1.5	1/2	5.6	2.75	1.41
143T	7	6.18	14.6	3.5	2.75	4	0.34	2.46	2.25	6.7	7.08	0.771	0.188	0.875	2	3/4	5.6	2.25	1.41
145T						5													
182T	8.5	6.5	18.8	4.5	3.75	4.5	0.41	2.98	2.75	9.25	9.65	0.986	0.25	1.125	2.5	3/4	7.2	2.75	1.78
184T						5.5													
213T	9.5	8	20.5	5.25	4.25	5.5	0.41	3.66	3.38	9.84	10	1.201	0.312	1.375	3.12	1	7.5	3.5	2.41
215T						7													

Three-Phase TEFC Rolled Steel Motors

C-Face / 48 to 215T Frame

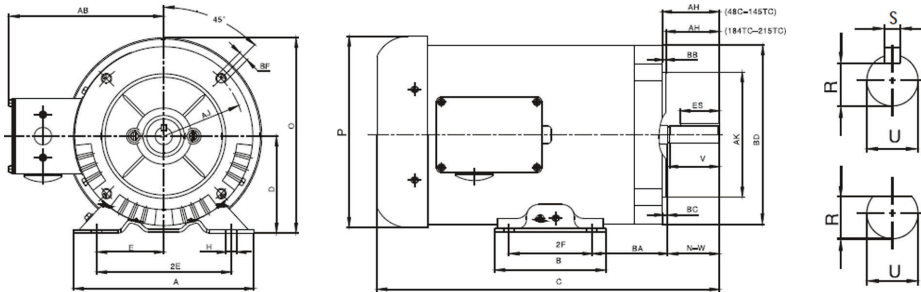

FRAME	A	MAX B	C	D	E	2F	H	N-W	O	P	R	S	U	MIN V	MIN AA	AB	AH	AJ	AK	BA	MAX BB	BC	MAX BD	BF	MIN ES
48C	6	3.8	10	3	2.12	2.75	0.34	1.5	5.83	5.66	0.453	-	0.5	1.125	1/2	5.3	1.69	3.75	3	2.5	0.16	-0.19	5.625	1/4-20	-
56C	6.5	4.2	12.7	3.5	2.44	3	0.34	1.88	6.7	7.08	0.517	0.188	0.625	1.5	1/2	5.6	2.06	5.875	4.5	2.75	0.16	-0.19	6.5	3/8-16	1.41
143TC	7	6.18	14.6	3.5	2.75	4	0.34	2.25	6.7	7.08	0.771	0.188	0.875	2	3/4	5.6	2.12	5.875	4.5	2.75	0.16	0.12	6.5	1/2-13	1.41
145TC						5																			
182TC	8.5	6.5	18.5	4.5	3.75	4.5	0.41	2.75	9.25	9.65	0.986	0.25	1.125	2.5	3/4	7.2	2.62	7.25	8.5	3.5	0.25	0.12	9	1/2-13	1.78
184TC						5.5																			
213TC	9.5	8	20.5	5.25	4.25	5.5	0.41	3.38	9.84	10	1.201	0.312	1.375	3.12	1	7.5	3.12	7.25	8.5	4.25	0.25	0.25	9	1/2-13	2.41
215TC						7																			

CONTROLS

ENERGY STORAGE

MOTORS

PUMPS

VALVES

COMPRESSORS

PNEUMATICS

SAWMILLS

METAL RECYCLING

TRANSIT & RAILROAD

WATER & WASTEWATER

DIMENSIONS & MOUNTING

Three-Phase ODP Rolled Steel Motors

Foot Mount / 48 to 215T Frame

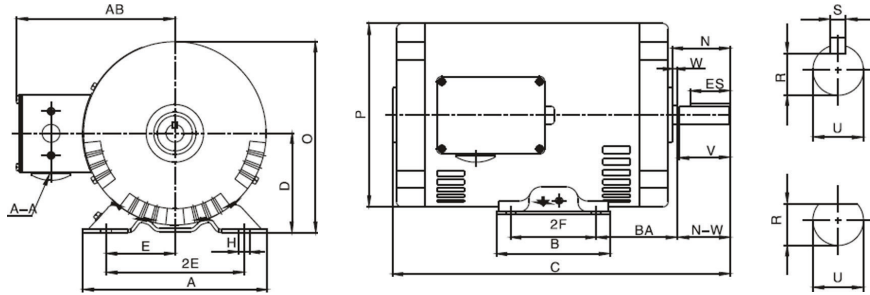

FRAME	MAX A	MAX B	C	D	E	2F	H	N	N-W	O	P	R	S	U	MIN V	MIN AA	AB	BA	MIN ES
48	6	3.8	10	3	2.2	2.75	0.34	1.62	1.5	5.83	5.66	0.453	-	0.5	1.125	1/2	5.3	2.5	-
56	6.5	4.2	11.4	3.5	2.44	3	0.34	2.4	1.88	6.7	6.45	0.517	0.188	0.625	1.5	1/2	5.6	2.75	1.41
143T	7	6.18	13.3	3.5	2.75	4	0.34	2.46	2.25	6.7	6.45	0.771	0.188	0.875	2	3/4	5.6	2.25	1.41
145T						5													
182T	8.5	6.5	16.5	4.5	3.75	4.5	0.41	2.98	2.75	9.25	8.5	0.986	0.25	1.125	2.5	3/4	7.2	2.75	1.78
184T						5.5													
213T	9.5	8	18	5.25	4.25	5.5	0.41	3.66	3.38	9.84	9	1.201	0.312	1.375	3.12	1	7.5	3.5	2.41
215T						7													

CONTROLS
ENERGY STORAGE
MOTORS
PUMPS
VALVES
COMPRESSORS
PNEUMATICS
SAWMILLS
METAL RECYCLING
TRANSIT & RAILROAD
WATER & WASTEWATER
DIMENSIONS & MOUNTING

Three-Phase ODP Rolled Steel Motors

C-Face / 48 to 215TC Frame

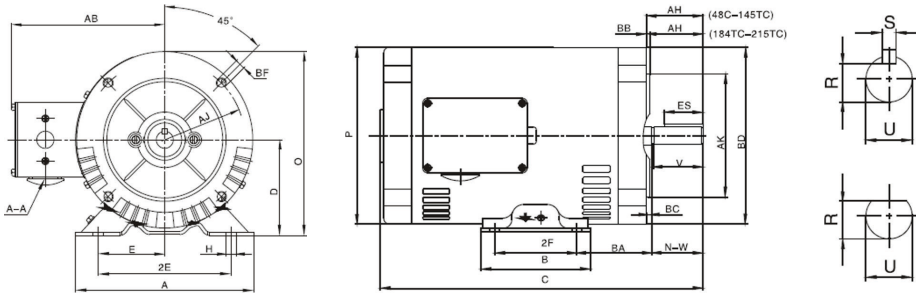

FRAME	MAX A	MAX B	C	D	E	2F	H	N-W	O	P	R	S	U	MIN V	MIN AA	AB	AH	AJ	AK	BA	MAX BB	BC	MAX BD	BF	MIN ES
48C	6	3.8	10	3	2.12	2.75	0.34	1.5	5.83	5.66	0.453	-	0.5	1.125	1/2	5.3	1.69	3.75	3	2.5	0.16	-0.19	5.625	1/4-20	-
56C	6.5	4.2	11.4	3.5	2.44	3	0.34	1.88	6.7	7.08	0.517	0.188	0.625	1.5	1/2	5.6	2.06	5.875	4.5	2.75	0.16	-0.19	6.5	3/8-16	1.41
143TC	7	6.18	13.3	3.5	2.75	4	0.34	2.25	6.7	7.08	0.771	0.188	0.875	2	3/4	5.6	2.12	5.875	4.5	2.75	0.16	0.12	6.5	1/2-13	1.41
145TC						5																			
182TC	8.5	6.5	16.5	4.5	3.75	4.5	0.41	2.75	9.25	9.65	0.986	0.25	1.125	2.5	3/4	7.2	2.62	7.25	8.5	3.5	0.25	0.12	9	1/2-13	1.78
184TC						5.5																			
213TC	9.5	8	18	5.25	4.25	5.5	0.41	3.38	9.84	9	1.201	0.312	1.375	3.12	1	7.5	3.12	7.25	8.5	4.25	0.25	0.25	9	1/2-13	2.41
215TC						7																			

CONTROLS

ENERGY STORAGE

MOTORS

PUMPS

VALVES

COMPRESSORS

PNEUMATICS

SAWMILLS

METAL RECYCLING

TRANSIT & RAILROAD

WATER & WASTEWATER

DIMENSIONS & MOUNTING

Premium Efficient TEFC Cast Iron Motors

Foot Mount / 143T to 5011TC Frame

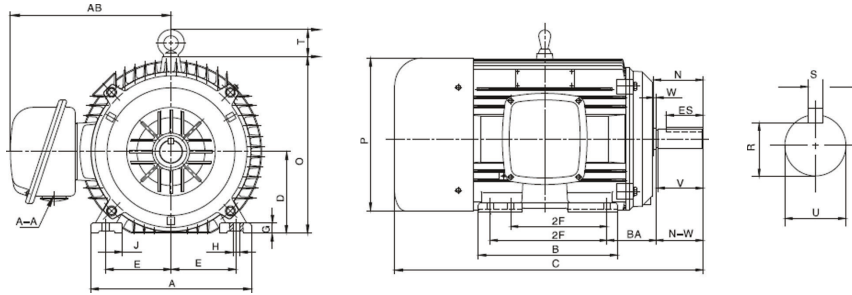

FRAME	A	B	C	D	E	2F	G	H	J	N	N-W	O	P	R	S	T	U
143T / 145T	7	6	15.35	3.5	2.75	4 / 5	0.52	0.34	1.58	2.44	2.25	7.52	7.68	0.771	0.188	1.42	0.875
182T / 184T	9	7.3	17.72	4.5	3.75	4.5 / 5.5	0.67	0.41	1.97	2.99	2.75	9.83	10.16	0.986	0.25	1.73	1.125
213T / 215T	10.5	9.4	22.25	5.25	4.25	5.5 / 7	0.73	0.41	2.2	3.65	3.38	11.62	11.65	1.201	0.312	2.05	1.375
254T / 256T	12.3	12	27	6.25	5	8.25 / 10	0.79	0.53	2.44	4.4	4	13.8	13.98	1.416	0.375	2.05	1.625
284T / 286T	13.8	13.6	30.2	7	5.5	9.5 / 11	0.87	0.53	2.84	5.02	4.62	15.6	15.63	1.591	0.5	2.44	1.875
284TS / 286TS	13.8	13.6	28.83	7	5.5	9.5 / 11	0.87	0.53	2.84	5.02	3.25	15.6	15.63	1.416	0.375	2.44	1.625
324T / 326T	15.3	14.1	32.4	8	6.25	10.5 / 12	1.03	0.66	2.95	5.25	5.25	17.32	17.46	1.845	0.5	2.44	2.125
324TS / 326TS	15.3	14.1	30.9	8	6.25	10.5 / 12	1.03	0.66	2.95	5.65	3.75	17.32	17.46	1.591	0.5	2.44	1.875
364T / 365T	17.2	16.2	36.5	9	7	11.25 / 12.25	1.1	0.66	3.23	6.28	5.88	18.98	19.06	2.021	0.625	2.44	2.375
364TS / 365TS	17.2	16.2	34.02	9	7	11.25 / 12.25	1.1	0.66	3.23	6.28	3.75	18.98	19.06	1.591	0.5	2.44	1.875
404T / 405T	19.22	20	41.36	10	8	12.25 / 13.75	1.2	0.81	3.35	7.28	7.25	20.96	21.56	2.45	0.75	2.84	2.875
404TS / 405TS	19.22	20	38.36	10	8	12.25 / 13.75	1.2	0.81	3.35	7.73	4.25	20.96	21.56	1.845	0.5	2.84	2.215
444T / 445T	21.76	21.26	47.25	11	9	14.5 / 16.5	1.2	0.81	3.74	8.98	8.5	23.5	23.35	2.88	0.875	4.1	3.375
444TS / 445TS	21.76	21.26	43.5	11	9	14.5 / 16.5	1.2	0.81	3.74	8.98	4.75	23.5	23.35	2.021	0.625	4.1	2.375
447T / 449T	21.76	28.74	53.55	11	9	20 / 25	1.2	0.81	3.74	8.98	8.5	23.5	23.35	2.88	0.875	4.1	3.375
447TS / 449TS	21.76	28.74	49.8	11	9	20 / 25	1.2	0.81	3.74	8.98	4.75	23.5	23.35	2.021	0.625	4.1	2.375
5007TS / 5011TS	28.7	31.1	64.8	14.5	11	20 / 25	2.05	1.125	4.72	12.125	11.625	28.4	28.2	3.309	1	5	3.825

CONTROLS
ENERGY STORAGE
MOTORS
PUMPS
VALVES
COMPRESSORS
PNEUMATICS
SAWMILLS
METAL RECYCLING
TRANSIT & RAILROAD
WATER & WASTEWATER
DIMENSIONS & MOUNTING

(Continued)

FRAME	MIN V	AA	AB	BA	MIN ES
143T / 145T	2	3/4	7.36	2.25	1.41
182T / 184T	2.5	3/4	8.66	2.75	1.78
213T / 215T	3.12	1	9.65	3.5	2.41
254T / 256T	3.75	1.25	12.26	4.25	2.91
284T / 286T	4.38	1.5	13.98	4.75	3.28
284TS / 286TS	3	1.5	13.98	4.75	1.91
324T / 326T	5	2	15.55	5.25	3.91
324TS / 326TS	3.5	2	15.55	5.25	2.03
364T / 365T	5.62	3	16.56	5.88	4.28
364TS / 365TS	3.5	3	16.56	5.88	2.03
404T / 405T	7	3	18.37	6.62	5.65
404TS / 405TS	4	3	18.37	6.62	2.78
444T / 445T	8.25	3	20.87	7.5	6.91
444TS / 445TS	4.5	3	20.87	7.5	3.03
447T / 449T	8.25	3	20.87	7.5	6.91
447TS / 449TS	4.5	3	20.87	7.5	3.03
5007TS / 5011TS	-	2x3	24	10	10

CONTROLS

ENERGY STORAGE

MOTORS

PUMPS

VALVES

COMPRESSORS

PNEUMATICS

SAWMILLS

METAL RECYCLING

TRANSIT & RAILROAD

WATER & WASTEWATER

DIMENSIONS & MOUNTING

Premium Efficient TEFC Cast Iron Motors

C-Face / 143TC to 449TSC Frame

143TC–326TC

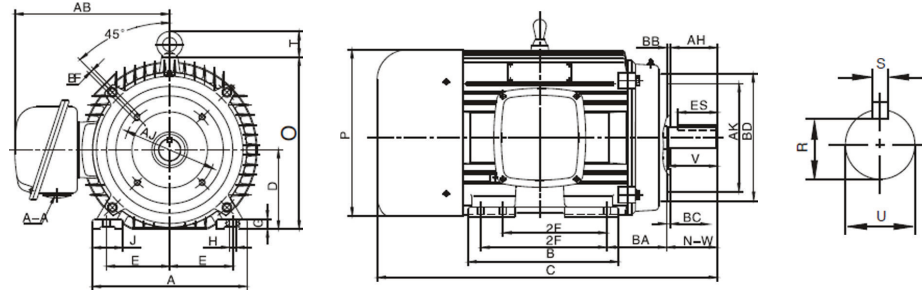

364TC–449TSC

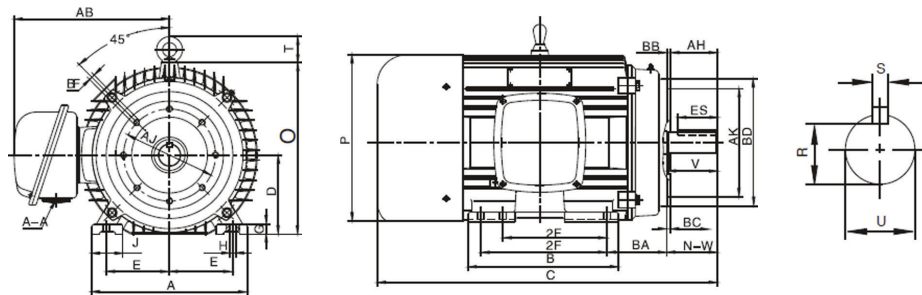

FRAME	A	B	C	D	E	2F	G	H	J	N	N-W	O	P
143TC / 145TC	7	6	15.35	3.5	2.75	4 / 5	0.52	0.34	1.58	2.44	2.25	7.52	7.68
182TC / 184TC	9	7.3	17.72	4.5	3.75	4.5 / 5.5	0.67	0.41	1.97	2.99	2.75	9.83	10.16
213TC / 215TC	10.5	9.4	22.25	5.25	4.25	5.5 / 7	0.73	0.41	2.2	3.65	3.38	11.62	11.65
254TC / 256TC	12.3	12	27	6.25	5	8.25 / 10	0.79	0.53	2.44	4.4	4	13.8	13.98
284TC / 286TC	13.8	13.6	30.2	7	5.5	9.5 / 11	0.87	0.53	2.84	5.02	4.62	15.6	15.63
284TSC / 286TSC	13.8	13.6	28.83	7	5.5	9.5 / 11	0.87	0.53	2.84	5.02	3.25	15.6	15.63
324TC / 326TC	15.3	14.1	32.4	8	6.25	10.5 / 12	1.03	0.66	2.95	5.25	5.25	17.32	17.46
324TSC / 326TSC	15.3	14.1	30.9	8	6.25	10.5 / 12	1.03	0.66	2.95	5.65	3.75	17.32	17.46
364TC / 365TC	17.2	16.2	36.5	9	7	11.25 / 12.25	1.1	0.66	3.23	6.28	5.88	18.98	19.06
364TSC / 365TSC	17.2	16.2	34.02	9	7	11.25 / 12.25	1.1	0.66	3.23	6.28	3.75	18.98	19.06
404TC / 405TC	19.22	20	41.36	10	8	12.25 / 13.75	1.2	0.81	3.35	7.28	7.25	20.96	21.56
404TSC / 405TSC	19.22	20	38.36	10	8	12.25 / 13.75	1.2	0.81	3.35	7.73	4.25	20.96	21.56
444TC / 445TC	21.76	21.26	47.25	11	9	14.5 / 16.5	1.2	0.81	3.74	8.98	8.5	23.5	23.35
444TSC / 445TSC	21.76	21.26	43.5	11	9	14.5 / 16.5	1.2	0.81	3.74	8.98	4.75	23.5	23.35
447TC / 449TC	21.76	28.74	53.55	11	9	20 / 25	1.2	0.81	3.74	8.98	8.5	23.5	23.35
447TSC / 449TSC	21.76	28.74	49.8	11	9	20 / 25	1.2	0.81	3.74	8.98	4.75	23.5	23.35

CONTROLS
 ENERGY STORAGE
 MOTORS
 PUMPS
 VALVES
 COMPRESSORS
 PNEUMATICS
 SAWMILLS
 METAL RECYCLING
 TRANSIT & RAILROAD
 WATER & WASTEWATER
 DIMENSIONS & MOUNTING

(Continued)

R	S	T	U	MIN V	AA	AB	AH	AJ	AK	BA	BB	BC	BD	BF	MIN ES
0.771	0.188	1.42	0.875	2	3/4	7.36	2.12	5.875	4.5	2.25	0.16	0.12	6.5	3/8-16	1.41
0.986	0.25	1.73	1.125	2.5	3/4	8.66	2.62	7.25	8.5	2.75	0.25	0.12	9	1/2-13	1.78
1.201	0.312	2.05	1.375	3.12	1	9.65	3.12	7.25	8.5	3.5	0.25	0.25	9	1/2-13	2.41
1.416	0.375	2.05	1.625	3.75	1.25	12.26	3.75	7.25	8.5	4.25	0.25	0.25	10	1/2-13	2.91
1.591	0.5	2.44	1.875	4.38	1.5	13.98	4.38	9	10.5	4.75	0.25	0.25	11.25	1/2-13	3.28
1.416	0.375	2.44	1.625	3	1.5	13.98	3	9	10.5	4.75	0.25	0.25	11.25	1/2-13	1.91
1.845	0.5	2.44	2.125	5	2	15.55	5	11	12.5	5.25	0.25	0.25	14	5/8-11	3.91
1.591	0.5	2.44	1.875	3.5	2	15.55	3.5	11	12.5	5.25	0.25	0.25	14	5/8-11	2.03
2.021	0.625	2.44	2.375	5.62	3	16.56	5.62	11	12.5	5.88	0.25	0.25	14	5/8-11	4.28
1.591	0.5	2.44	1.875	3.5	3	16.56	3.5	11	12.5	5.88	0.25	0.25	14	5/8-11	2.03
2.45	0.75	2.84	2.875	7	3	18.37	7	11	12.5	6.62	0.25	0.25	15.5	5/8-11	5.65
1.845	0.5	2.84	2.215	4	3	18.37	4	11	12.5	6.62	0.25	0.25	15.5	5/8-11	2.78
2.88	0.875	4.1	3.375	8.25	3	20.87	8.25	14	16	7.5	0.25	0.25	18	5/8-11	6.91
2.021	0.625	4.1	2.375	4.5	3	20.87	4.5	14	16	7.5	0.25	0.25	18	5/8-11	3.03
2.88	0.875	4.1	3.375	8.25	3	20.87	8.25	14	16	7.5	0.25	0.25	18	5/8-11	6.91
2.021	0.625	4.1	2.375	4.5	3	20.87	4.5	14	16	7.5	0.25	0.25	18	5/8-11	3.03

CONTROLS

ENERGY STORAGE

MOTORS

PUMPS

VALVES

COMPRESSORS

PNEUMATICS

SAWMILLS

METAL RECYCLING

TRANSIT & RAILROAD

WATER & WASTEWATER

DIMENSIONS & MOUNTING

Premium Efficient ODP Cast Iron Motors

Foot Mount / 254/6T to 444/5T Frame

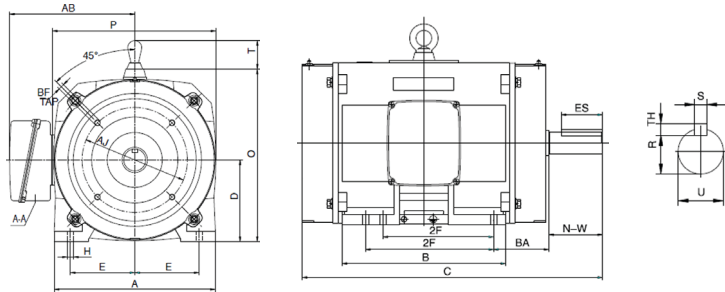

FRAME	A	B	C	D	E	2F	H	N-W	O+T	P	R	S	U	A-A	AB	BA	ES	TH
254 / 6T	12.2	9.84 / 11.57	20.67 / 22.4	6.25	5	8.25 / 10	4-0.35	4	14.55	12.8	1.416	0.375	1.625	2.05	11.1	4.25	2.875	0.375
284 / 6T	12.76	11.26 / 12.76	23.82 / 25.32	7	5.5	9.5 / 11	4-0.53	4.62	16.84	14.76	1.591	0.5	1.875	2.84	13.18	4.75	3.25	0.5
324 / 6T	14.88	12.68 / 14.17	26.26 / 27.76	8	6.25	10.5 / 12	4-0.66	5.25	18.82	16.69	1.845	0.5	2.125	2.84	14.09	5.25	3.875	0.5
364 / 5T	16.38	13.43 / 14.41	29.13 / 30.13	9	7	11.25 / 12.25	4-0.66	5.88	21.05	18.31	2.021	0.625	2.375	3.58	16.33	5.88	4.25	0.625
404 / 5T	19.69	14.96 / 16.54	33.1 / 34.6	10	8	12.25 / 13.75	4-0.81	7.25	23.78	20.24	2.45	0.75	2.875	4.64	20.08	6.62	5.625	0.75
444 / 5T	22.05	17.32 / 19.29	37.7 / 39.7	11	9	14.5 / 16.5	4-0.81	8.5	26.35	22.05	2.88	0.875	3.375	4.64	20.8	7.5	6.91	0.875

Premium Efficient ODP Cast Iron Motors

C-Face / 254TC to 445TC Frame

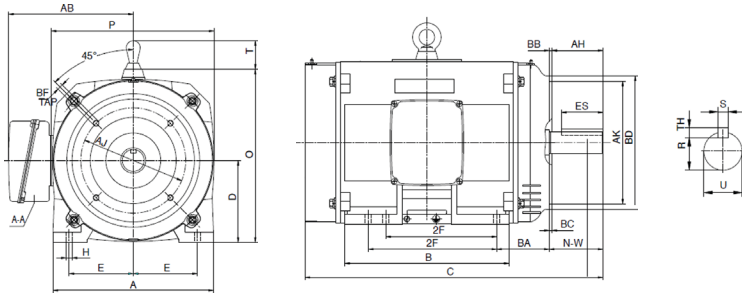

FRAME	A	B	C	D	E	2F	H	N-W	O+T	P	R	S	P	R	U	A-A	AB	AH
254 / 6TC	12.2	9.84 / 11.57	20.67 / 22.4	6.25	5	8.25 / 10	4-40.53	4	14.55	12.8	1.416	0.375	12.8	1.416	1.625	1-1/4	11.1	3.75
284 / 6TC	12.76	11.26 / 12.76	23.82 / 25.32	7	5.5	9.5 / 11	4-40.53	4.62	16.84	14.76	1.591	0.5	14.76	1.591	1.875	1-1/2	13.18	4.38
324 / 6TC	14.88	12.68 / 14.17	26.26 / 27.76	8	6.25	10.5 / 12	4-40.66	5.25	18.82	16.69	1.845	0.5	16.69	1.845	2.125	2	14.09	5
364 / 5TC	16.38	13.43 / 14.41	29.13 / 30.13	9	7	11.25 / 12.25	4-40.66	5.88	21.05	18.31	2.021	0.625	18.31	2.021	2.375	3	16.58	5.62
404 / 5TC	19.69	14.96 / 16.54	33.1 / 34.6	10	8	12.25 / 13.75	4-40.81	7.25	23.78	20.24	2.45	0.75	20.24	2.45	2.875	3	20.08	7
444 / 5TC	22.05	17.32 / 19.29	37.7 / 39.7	11	9	14.5 / 16.5	4-40.81	8.5	26.35	22.05	2.88	0.875	22.05	2.88	3.375	3	20.86	8.25

FRAME	AJ	AK	BA	BB	BC	BD	ES	TH	BE MOLE		
									NUMBER	TAP SIZE	BOLT PENETRATION ALLOWANCE
254 / 6TC	7.25	8.5	4.25	0.25	0.25	10	2.875	0.375	4	1/2-13	0.75
284 / 6TC	9	10.5	4.75	0.25	0.25	11.25	3.25	0.5	4	1/2-13	0.75
324 / 6TC	11	12.5	5.25	0.25	0.25	14	3.875	0.5	4	5/8-11	0.94
364 / 5TC	11	12.5	5.88	0.25	0.25	14	4.15	0.625	8	5/8-11	0.94
404 / 5TC	11	12.5	6.62	0.25	0.25	15.5	5.625	0.75	8	5/8-11	0.94
444 / 5TC	14	16	7.5	0.25	0.25	18	6.91	0.875	8	5/8-11	0.94

EISA High Efficient TEFC Aluminum Motors

Foot Mount / 48 to 286T Frame

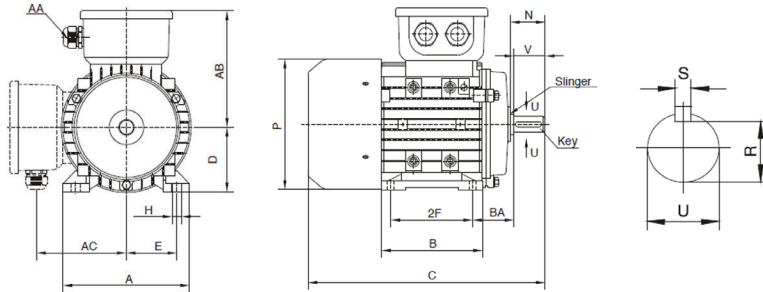

FRAME	A	B	C	D	E	2F	H	KEY	N	O	P	S	R	U	V	AA	AB	AC	BA
48	6	3.6	10.5	3	2.12	2.75	0.34		1.62	5.85	5.4	0.188	0.453	0.5	1.5	0.5	4.65	3.5	2.5
56	7	4	13.5	3.5	2.44	3	0.34	0.188	2	7.34	7.68	0.188	0.517	0.625	1.88	0.5	5.5	4.5	2.75
143T	6.5	5.88	12.5	3.5	2.75	5	0.38	0.19	2.5	7.48	8	0.188	0.771	0.875	2.25	0.75	6.38	5	2.25
145T			13.5																
182T	8.62	6.5	16	4.5	3.75	4.5	0.41	0.25	2.81	9.23	10.12	0.25	0.986	1.125	2.75	0.75	7.12	5.75	2.75
184T						5.5													
213T	9.62	8.12	19	5.25	4.25	5.5	0.41	0.31	3.88	10.99	12.18	0.312	1.201	1.375	3.38	1	9.22	7.43	3.5
215T			20			7													
245T	11.5	11.5	24.5	6.25	5	8.25	0.53	0.38	4.2	12.96	13.44	0.375	1.418	1.625	4	1.25	10.48	8.66	4.25
256T			26.5			10													
284T	12.76	12.75	30	7	5.5	9.5	0.53	0.38	4.88	14.74	15.54	0.5	1.591	1.875	4.63	1.5	12.46	10.14	4.75
286T			32			11													

CONTROLS
ENERGY STORAGE
MOTORS
PUMPS
VALVES
COMPRESSORS
PNEUMATICS
SAWMILLS
METAL RECYCLING
TRANSIT & RAILROAD
WATER & WASTEWATER
DIMENSIONS & MOUNTING

EISA High Efficient TEFC Aluminum Motors

C-Face / 48C to 286TC Frame

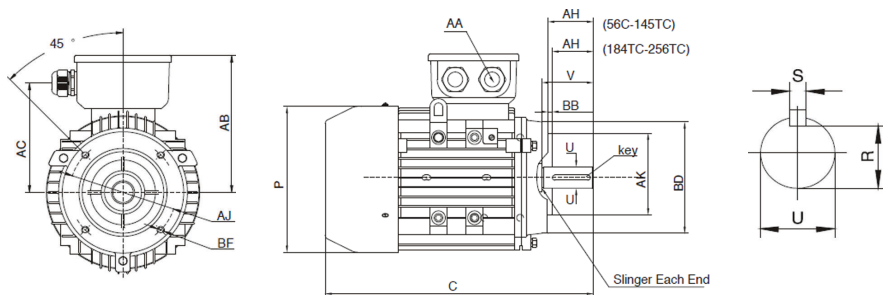

FRAME	C	KEY	O	P	R	S	U	V	AA	AB	AC	AH	AJ	AK	BB	BD	TAP BF
48C	10.5	-	5.85	5.7	-	0.453	0.5	1.5	0.5	4.65	3.5	1.69	5.75	3	0.16	5.625	1/4-20
56C	13.5	0.34	7.34	7.68	0.188	0.517	0.625	1.88	0.5	5.5	4.5	2.06	5.875	4.5	0.16	6.5	3/8-16
143TC	12.5	0.19	7.48	8	0.188	0.771	0.875	2.12	0.75	6.38	5	2.25	5.88	4.5	0.13	6.51	0.38-16
145TC	13.5																
182TC	16	0.25	9.23	10.12	0.25	0.986	1.125	2.62	0.75	7.12	5.75	2.75	7.25	8.5	0.25	9	0.5-13
184TC																	
213TC	19	0.31	10.99	12.18	0.312	1.201	1.375	3.38	1	9.22	7.43	3.15	7.25	8.5	0.25	9.06	0.5-13
215TC	20																
254TC	24.5	0.38	12.96	13.44	0.375	1.416	1.625	4	1.25	10.48	8.66	3.75	7.25	8.5	0.25	9.13	0.5-13
256TC	26.5																
284TC	30	0.38	14.74	15.54	0.05	1.591	1.875	4.63	1.5	12.46	10.14	4.38	9	10.5	0.25	11.23	0.5-13
286TC	32																

CONTROLS

ENERGY STORAGE

MOTORS

PUMPS

VALVES

COMPRESSORS

PNEUMATICS

SAWMILLS

METAL RECYCLING

TRANSIT & RAILROAD

WATER & WASTEWATER

DIMENSIONS & MOUNTING

Medium Voltage TEFC Cast Iron/Steel Motors

C-Face / N5009 to N6810 Frame

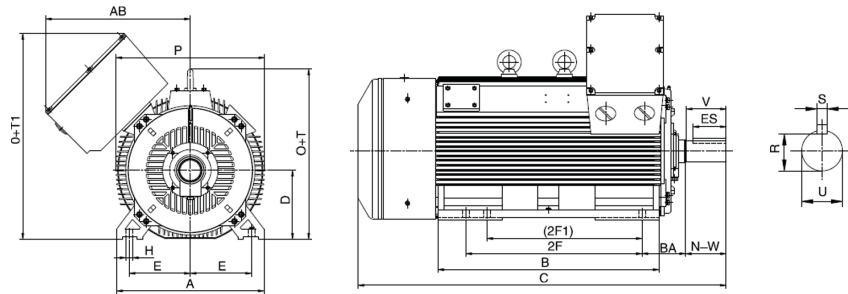

FRAME	POLES	A	B	C	D	E	2F	2F1	H	N-W	O+T	O+T1	P	R	S	U	V	AB	BA	ES
N5009	2	24.8	33.86	69.9	12.5	10	28	22	1.1	5.5	30.4	33.4	27.8	2.275	0.625	2.625	5.3	27.8	8.5	4.75
	4~10	24.8	33.86	67.4	12.5	10	28	22	1.1	6.7	30.4	33.4	27.8	3.261	0.875	3.75	6.5	27.8	8.5	5.5
N5011	4~10	24.8	41.85	75.4	12.5	10	36	32	1.1	6.7	30.4	33.4	27.8	3.261	0.875	3.75	6.5	27.8	8.5	5.5
N5808	2	28	33.86	78.6	14.5	11.5	28	25	1.1	5.5	34.2	36.9	32.3	2.45	0.75	2.875	5.3	29.8	10	4.75
	4~10	28	33.86	73.3	14.5	11.5	28	25	1.1	8.3	34.2	36.9	32.3	3.817	1	4.375	8.1	29.8	10	6.7
N5810	2	28	41.85	86.1	14.5	11.5	36	32	1.1	5.5	34.2	36.9	32.3	2.45	0.75	2.875	5.3	29.8	10	4.75
	4~10	28	41.85	80.7	14.5	11.5	36	32	1.1	8.3	34.2	36.9	32.3	3.817	1	4.375	8.1	29.8	10	6.7
N6310	2	31.5	47.24	85.5	15.75	13.5	40	32	1.38	6.7	37	40.9	35.5	2.704	0.75	3.125	6.5	33.1	11	5.5
	4~10	31.5	47.24	80.7	15.75	13.5	40	32	1.38	8.3	37	40.9	35.5	3.817	1	4.375	8.1	33.1	11	6.7
	2	33.9	53.54	92	17	13.5	45	36	1.38	6.7	-	44	37.8	2.88	0.875	3.375	6.5	-	11.5	5.5
N6810	4~10	33.9	53.54	90.2	17	13.5	45	36	1.38	8.3	-	44	37.8	4.169	1.25	4.875	8.1	-	11.5	6.7

CONTROLS
 ENERGY STORAGE
 MOTORS
 PUMPS
 VALVES
 COMPRESSORS
 PNEUMATICS
 SAWMILLS
 METAL RECYCLING
 TRANSIT & RAILROAD
 WATER & WASTEWATER
 DIMENSIONS & MOUNTING

Crusher Duty ODP Motors

Foot Mount / 450T to 7UZ Frame

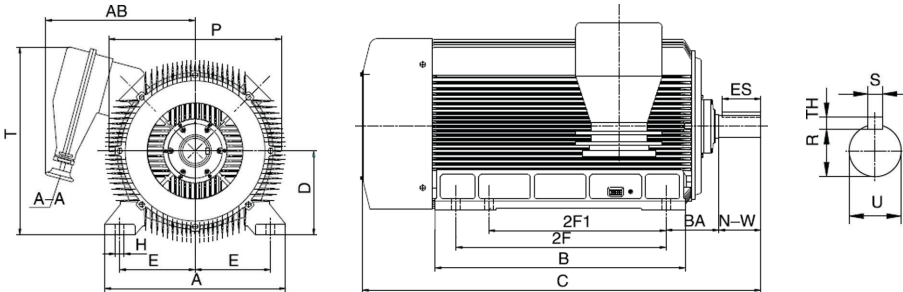

FRAME	A	B	C	D	2E	2F	2F1	H	N-W	P	R	S	T	U	AA	AB	BA	ES	TH
450T	19.22	18.25	41.36	10	16	13.75	12.25	4-0.81	7.25	21.56	2.45	0.75	25.6	2.875	1-NPT3	21.12	6.62	5.65	0.75
444T	22.05	18.75	47.8	11	18	14.5	-	4-0.81	8.5	25.83	2.88	0.875	26.54	3.375	1-NPT3	22.24	7.5	6.91	0.875
445T	22.05	19.29	48.1	11	18	16.5	14.5	4-0.81	8.5	25.83	2.88	0.875	26.54	3.375	1-NPT3	22.24	7.5	6.91	0.875
447T	22.05	22.83	59.24	11	18	20	-	4-0.81	10.125	26.77	2.88	0.875	27.83	3.375	1-NPT3.5	22.95	7.5	8.5	0.875
449T	22.05	27.83	64.54	11	18	25	20	4-0.81	10.125	26.77	2.88	0.875	27.83	3.375	1-NPT3.5	22.95	7.5	8.5	0.875
505T	24.8	20.87	56.12	12.5	20	18	16	4-0.94	11.625	26.77	3.309	1	30.2	3.875	1-NPT4	21.85	8.5	10	1
586/7UZ	28	29.72	71.02	14.5	22	25	22	6-1.1	11.625	33	3.817	1	33.2	4.375	2-NPT3	30.94	10	10	1

CONTROLS

ENERGY STORAGE

MOTORS

PUMPS

VALVES

COMPRESSORS

PNEUMATICS

SAWMILLS

METAL RECYCLING

TRANSIT & RAILROAD

WATER & WASTEWATER

DIMENSIONS & MOUNTING

Close-Coupled Pump TEFC Motors

143 JM/JP to 365 JM/JP Frame

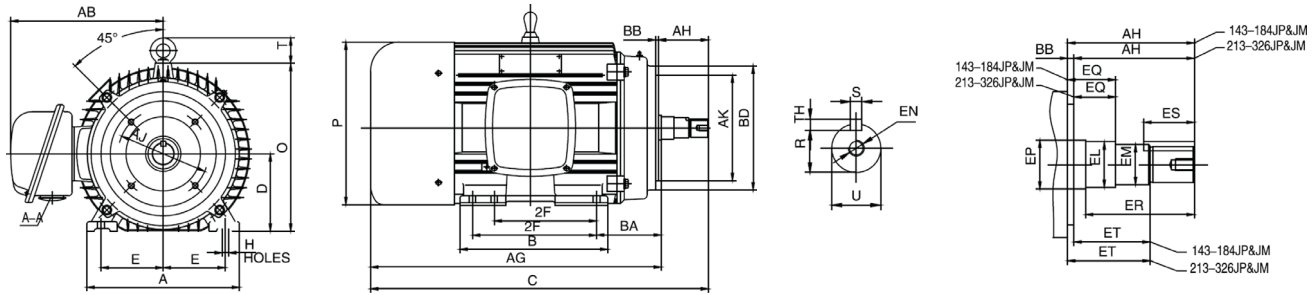

FRAME	A	B	D	E	2F	H	O	P	T	AA	AB	AG	AJ	AK	BA	BB	BD
143JM/JP	6.93	4.88	3.5	2.75	4	0.34	7.57	8.15	-	NPT 3/4	6.57	10.28	5.87	4.5	2.38	0.15	6.5
145JM/JP		5.87			5							11.23					
182JM/JP	8.66	5.59	4.5	3.75	4.5	0.41	9.22	9.55	1.65	NPT 3/4	7.39	11.92	5.87	4.5	2.88	0.15	6.5
184JM/JP		6.11			5.5							12.9					
213JM/JP	10.23	6.89	5.25	4.25	5.5	0.41	10.84	11.2	1.65	NPT 1	9.29	14.92	7.25	8.5	3.78	0.31	9
215JM/JP		8.39			7							16.41					
254JM/JP	12.12	9.84	6.25	5	8.25	0.53	12.6	12.8	2	NPT 1-1/4	11.14	19.71	7.25	8.5	4.25	0.31	10
256JM/JP		11.6			10							21.41					
284JM/JP	12.76	11.26	7	5.5	9.5	0.53	14.94	15.75	2.36	NPT 1-1/2	13.98	22.59	11	12.5	4.75	0.31	14
286JM/JP		12.76			11							24.09					
324JM/JP	14.88	12.68	8	6.25	10.5	0.66	16.77	17.75	2.36	NPT 2	14.37	24.76	11	12.5	5.25	0.31	14
326JM/JP		14.17			12							26.38					
364JM/JP	16.4	14.4	9	7	11.25	0.66	18.5	19.1	2.8	NPT 3	17.32	26.97	11	12.5	5.88	0.31	14
365JM/JP		15.4			12.25							27.95					

(Continued)

FRAME	C	R	S	U	AH	EL	EM	EN	EP	EQ	ER	ES	ET	TH
143JM	14.53	0.77	0.19	0.874	4.25	1.156	1	3/8-16 x 0.75	1.16	0.62	4.25	1.66	2.87	0.19
145JM	15.51					1.156			1.16					
182JM	16.17					1.25			1.25					
184JM	17.15					1.25			1.25					
213JM	19.17					1.25			1.75					
215JM	20.66					1.25			1.75					
254JM	24.96	1.11	0.25	1.249	5.25	1.75	1.375	1/2-13 x 1	1.75		5.25	2.53	3	0.25
256JM	26.66					1.75			1.75					
284JM	27.84					1.75			2.13					
286JM	29.34					1.75			2.13					
324JM	30.01					1.75			2.13					
326JM	31.63					1.75			2.13					

FRAME	C	R	S	U	AH	EL	EM	EN	EP	EQ	ER	ES	ET	TH														
143JP	17.59	0.77	0.19	0.874	7.31	1.156	1	3/8-16 x 0.75	1.16	0.62	7.31	1.66	5.93	0.19														
145JP	18.57					1.25			1.25																			
182JP	19.23					1.11			0.25						1.249	8.12	1.75	1.375	1/2-13 x 1	1.75	2.37	8.12	2.53	5.87				
184JP	20.21																								2.125	2.125		
213JP	23.04	1.41	0.375	1.624	8.12		2.125	1.75			1/2-13 x 1	2.5	2.37	8.12											2.53	5.87		
215JP	24.53																										0.375	0.375
254JP	27.83																										0.375	0.375
256JP	29.53																										0.375	0.375
284JP	30.71					0.375			0.375																			
286JP	32.21					0.375			0.375																			
324JP	32.88	1.41	0.375	1.624	8.12	2.125	1.75	1/2-13 x 1	2.5		2.37	8.12	2.53	5.87														
326JP	34.5														0.375	0.375												
364JP	35.09	1.41	0.375	1.624	8.12	2.125	1.75	1/2-13 x 1	2.5	2.37	8.12	2.53	5.87															
365JP	36.07													0.375	0.375													

CONTROLS

ENERGY STORAGE

MOTORS

PUMPS

VALVES

COMPRESSORS

PNEUMATICS

SAWMILLS

METAL RECYCLING

TRANSIT & RAILROAD

WATER & WASTEWATER

DIMENSIONS & MOUNTING

Stainless Steel TEFC Motors

C-Face / 56C to 215TC Frame

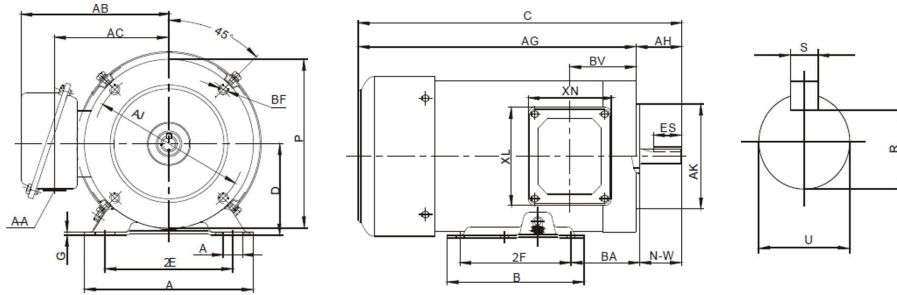

FRAME	MOUNTING						CONDUIT BOX						MOTOR					KEYSEAT				BEARINGS		
	A	B	D	E	2F	H	BA	AA	AB	AC	XN	XL	C	N-W	P	AH	AJ	AK	R	S	U	ES	ODE	DE
56C	6.5	6.5	3.5	2.44	3	1.22x34	2.75	0.86	5.75	4.25	3.8	4.72	11.59	1.88	6.5	2.06	5.875	4.5	0.517	0.188	0.625	1.41	6205Z	6205Z
143TC	6.5	6.5	3.5	2.75	4	1.22x34	2.75	0.86	5.75	4.25	3.8	4.72	12.63	1.88	6.5	2.12	5.875	4.5	0.517	0.188	0.625	1.41	6205Z	6205Z
145TC													13.68						2.25		0.771			
182TC	8.8	6.5	4.5	3.75	4.5	0.71x47	3.5	0.94	7	5.3	4.05	4.45	16.4	2.75	8.9	2.62	7.25	8.5	0.986	0.25	1.125	1.78	6307Z	6308Z
184TC													16.4											
213TC	10	8.5	5.25	4.25	5.5	0.71x47	4.25	0.94	7.6	6.2	4.05	4.45	21.5	3.38	10	3.12	7.25	8.5	1.201	0.312	1.375	2.41	6308Z	6308Z
215TC					7								22.3											

CONTROLS
ENERGY STORAGE
MOTORS
PUMPS
VALVES
COMPRESSORS
PNEUMATICS
SAWMILLS
METAL RECYCLING
TRANSIT & RAILROAD
WATER & WASTEWATER
DIMENSIONS & MOUNTING

SH Series Submersible HD Pumps

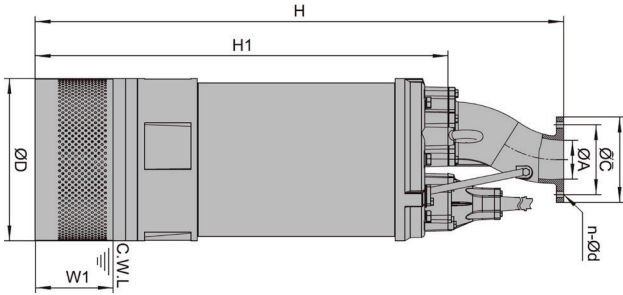

MODEL 50/60Hz	A	B	C	N-ØD	D	H	H1	W1	WT (NET)	WT (GROSS)	PACKING
SH422	100	180	220	8-Ø17.5	420	1374	1072	240	816	904	620 x 740 x 1540
SH430									827	915	
SH622	150	240	285	8-Ø22	420	1434	1082	250	849	937	620 x 740 x 1600
SH630									860	948	
SH637					1257	1356	680 x 740 x 1650				
SH645					1268	1367					
SH837	200	295	340	12-Ø22	530	1474	1072	180	1268	1378	680 x 740 x 1700
SH845									1279	1389	

PERFORMANCE CURVES

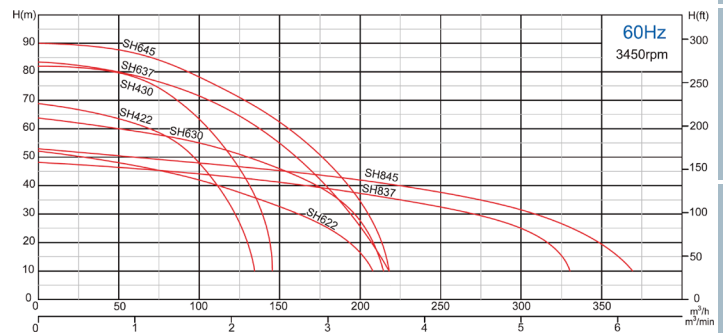
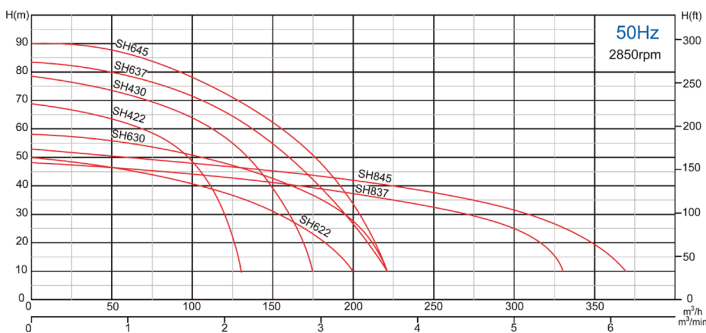

KBZ Series Submersible Drainage Pump

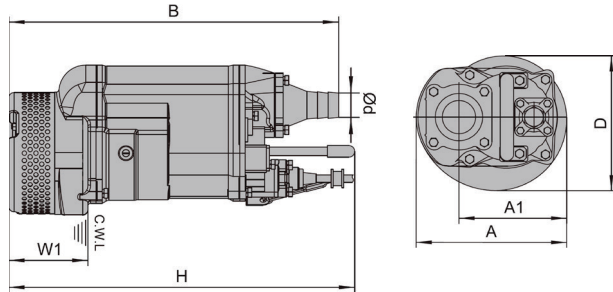

MODEL 50/60Hz	A	B	ØD	D	H	A1	W1	WT (NET)	WT (GROSS)	PACKING
KBZ21.5	235	535	50	216	505	173	120	79	88	610 x 365 x 365
KBZ31.5		535	80							
KBZ22.2		535	50					86	95	610 x 365 x 365
KBZ32.2		535	80							
KBZ23.7	283	628	50	252	629	208	150	139	150	710 x 320 x 295
KBZ33.7		628	80							
KBZ43.7		642	100							
KBZ35.5	283	671	80	252	590	208	150	170	185	750 x 350 x 360
KBZ45.5		686	100							
KBZ47.5	330	764	100	314	676	240	190	234	256	835 x 365 x 385
KBZ67.5		790	150					238	262	865 x 365 x 385
KBZ411		373	807					100	350	695

(Continued)

PERFORMANCE CURVES

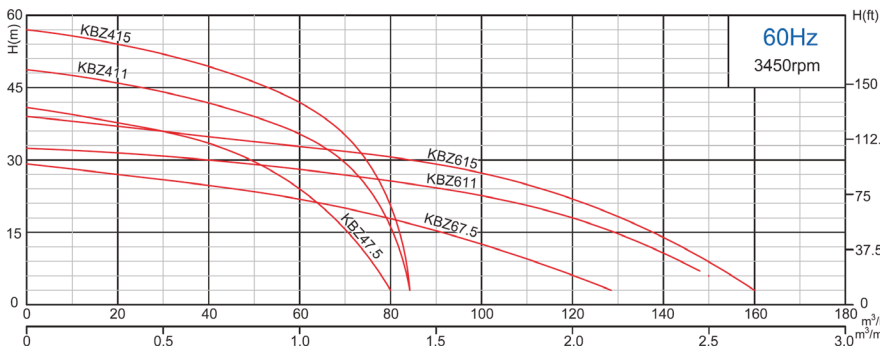
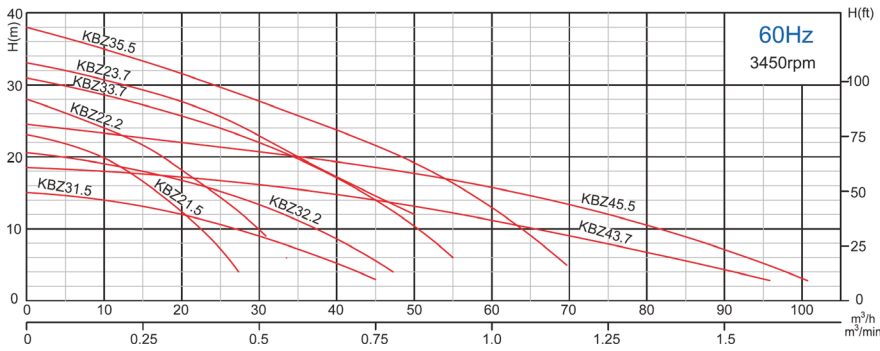
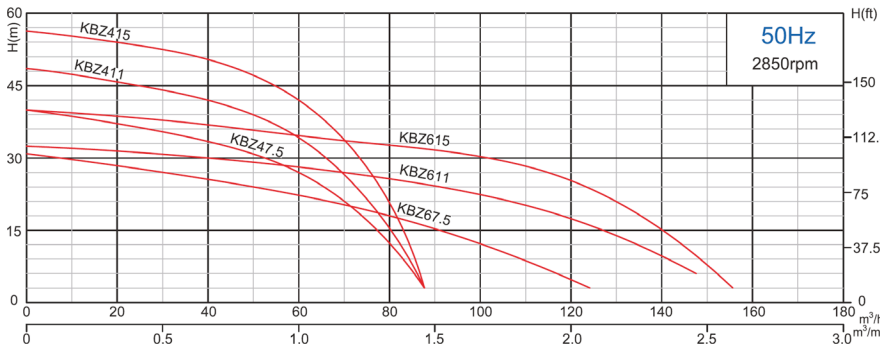
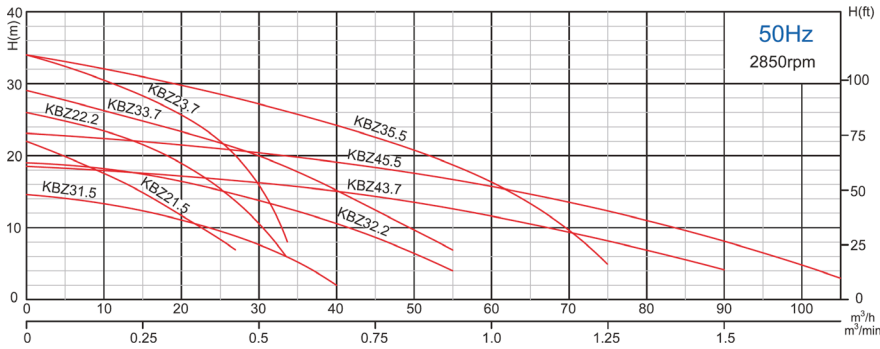

CONTROLS

ENERGY STORAGE

MOTORS

PUMPS

VALVES

COMPRESSORS

PNEUMATICS

SAWMILLS

METAL RECYCLING

TRANSIT & RAILROAD

WATER & WASTEWATER

DIMENSIONS & MOUNTING

MP-3 ANSI Centrifugal Pumps

Performance Graph

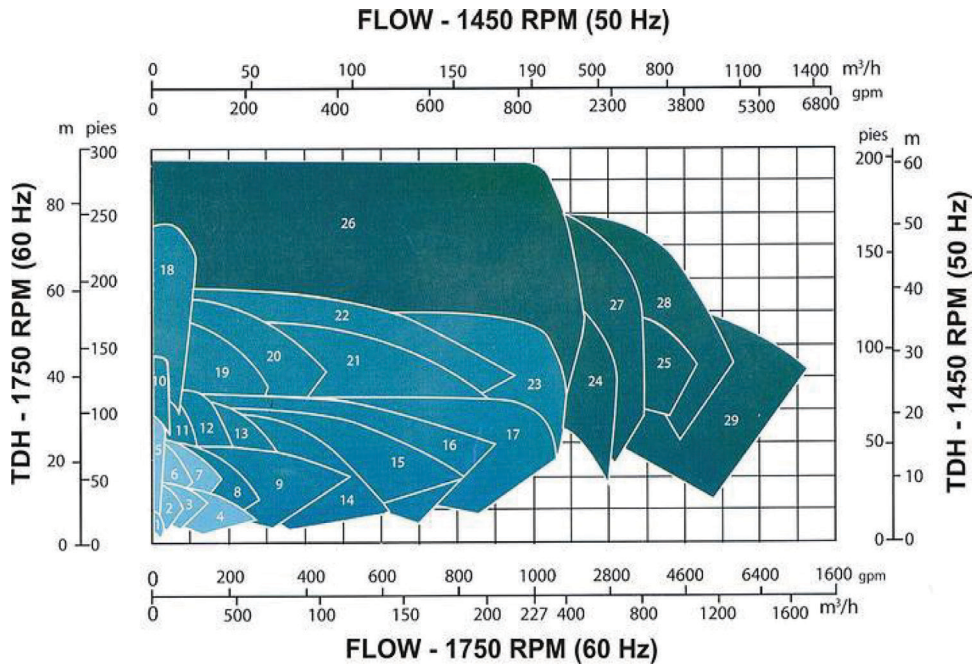

MP-6913 ANSI Centrifugal Pumps

Performance Graph

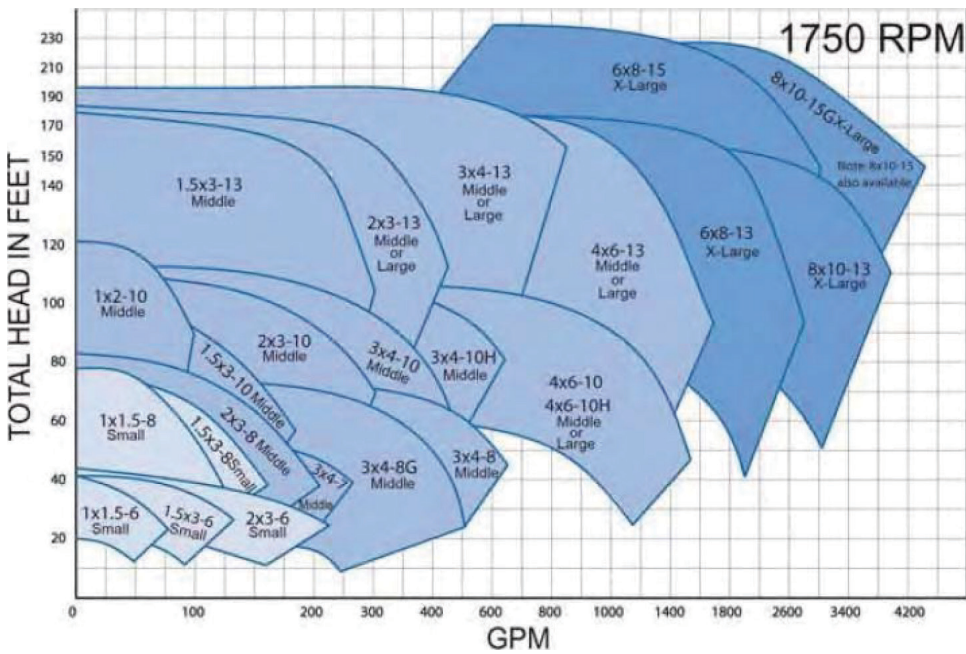
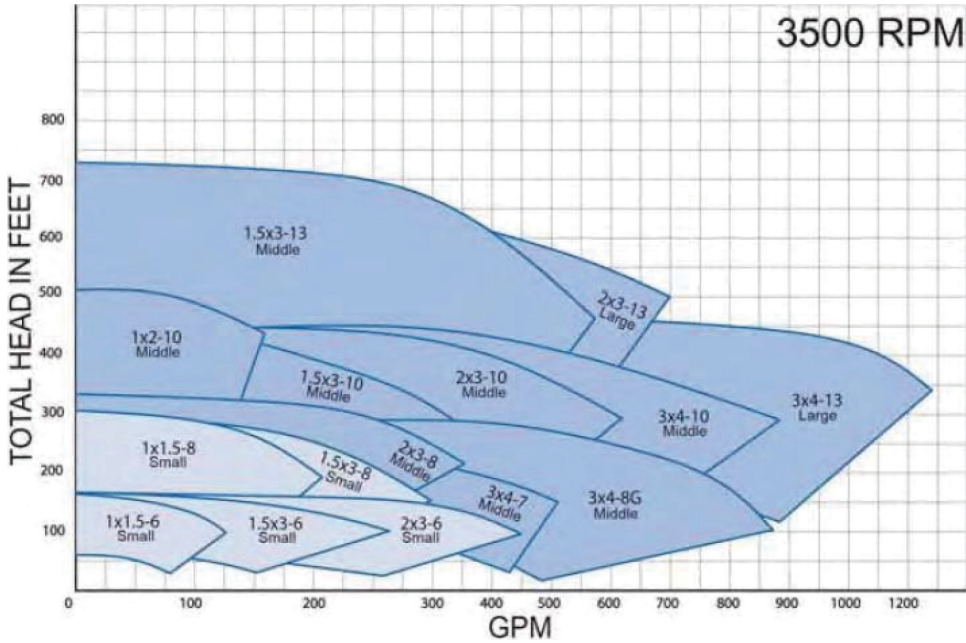

- CONTROLS
- ENERGY STORAGE
- MOTORS
- PUMPS
- VALVES
- COMPRESSORS
- PNEUMATICS
- SAWMILLS
- METAL RECYCLING
- TRANSIT & RAILROAD
- WATER & WASTEWATER
- DIMENSIONS & MOUNTING

MP-MAG-I Centrifugal Pumps

3x2x13 to 10x8x14 Size

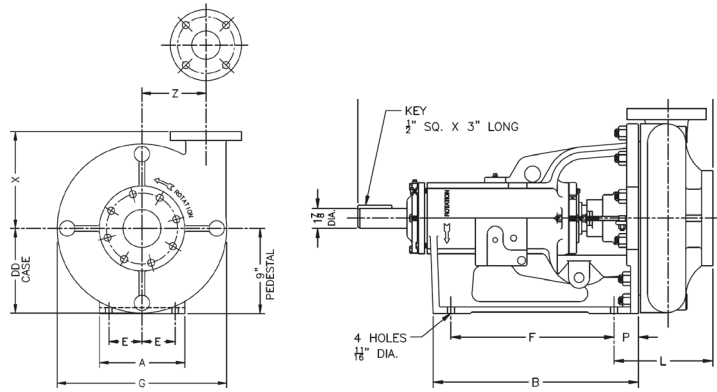

SIZE	SUCTION FLANGES		DISCHARGE FLANGES		A	B	E	F	G	L	P	X	Y	Z	CP	DD	WT
	SIZE	DRILLING	SIZE	DRILLING													
3x2x13	3	4 Holes, 3/4 D, 6 BC	2	4 Holes, 3/4 D, 4-3/4 BC	9	19-5/8	3-1/2	15-7/16	17-7/8	8-3/4	2-5/16	10-1/4	3-3/4	7	29-1/4	9	440 lbs
4x3x13	4	8 Holes, 3/4 D, 7-1/2 BC	3	4 Holes, 3/4 D, 6 BC					17-7/8	9-3/8		10-1/4	4-1/4	6-3/4	29-3/8	9	436 lbs
5x4x14	5	8 Holes, 7/8 D, 8-1/2 BC	4	8 Holes, 3/4 D, 7-1/2 BC					19	10-3/4		11	5	6-1/8	30	9-11/16	485 lbs
6x5x11	6	8 Holes, 7/8 D, 9-1/2 BC	5	8 Holes, 7/8 D, 8-1/2 BC					17-7/8	12-1/16		11	5-3/4	6	30-5/8	9	507 lbs
6x5x14	6	8 Holes, 7/8 D, 9-1/2 BC	5	8 Holes, 7/8 D, 8-1/2 BC					21	12-1/16		11	5-3/4	6	30-5/8	10-1/2	550 lbs
8x6x11	8	8 Holes, 7/8 D, 11-3/4 BC	6	8 Holes, 7/8 D, 9-1/2 BC					20	13-1/4		14	6-1/4	8-3/8	31-1/4	10	583 lbs
8x6x14	8	8 Holes, 7/8 D, 11-3/4 BC	6	8 Holes, 7/8 D, 9-1/2 BC					23-9/16	13-1/4		14	6-1/4	8-3/8	31-1/4	12	616 lbs
10x8x14	10	12 Holes, 1 D, 14-1/4 BC	8	8 Holes, 7/8 D, 11-3/4 BC					22-3/8	13-11/16		14-3/16	6-11/16	8	31-1/4	11-3/16	810 lbs

CONTROLS
ENERGY STORAGE
MOTORS
PUMPS
VALVES
COMPRESSORS
PNEUMATICS
SAWMILLS
METAL RECYCLING
TRANSIT & RAILROAD
WATER & WASTEWATER
DIMENSIONS & MOUNTING

MP-MAG-XP Centrifugal Pumps

8x6 XP to 14x12 XP Size

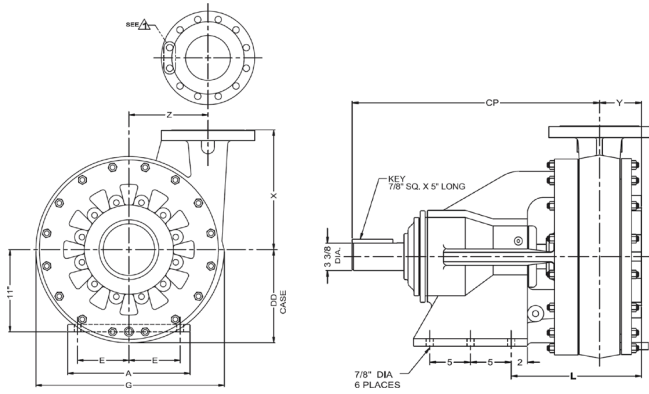

SIZE	SUCTION FLANGES		DISCHARGE FLANGES		A	E	G	L	X	Y	Z	CP	DD	WT
	SIZE	DRILLING	SIZE	DRILLING										
8 x 6 XP	8	12 Holes, 7/8 -9UNC-2B, 13 BC	6	12 Holes, 7/8 D, 10-5/8 BC	16-13/32	6-7/8	25-1/4	16-1/32	16	5-5/32	10-19/32	30-13/32	12-7/16	1200 lbs
10 x 12 XP	12	12 Holes, 3/4 -10UNC-2B, 17 BC	10	12 Holes, 1 D, 14-1/4 BC			33-5/8	18-11/16	22	6-15/16	13-1/2	31-1/2	16-13/16	1950 lbs
14 x 12 XP	14	12 Holes, 1-8UNC-2B, 18-3/4 BC	12	-			37-3/4	18-3/8	19-7/16	6-5/8	14-9/16	31-3/16	18-3/16	1850 lbs

MP-2500 Centrifugal Pumps

3x2x13 to 10x8x14 Size

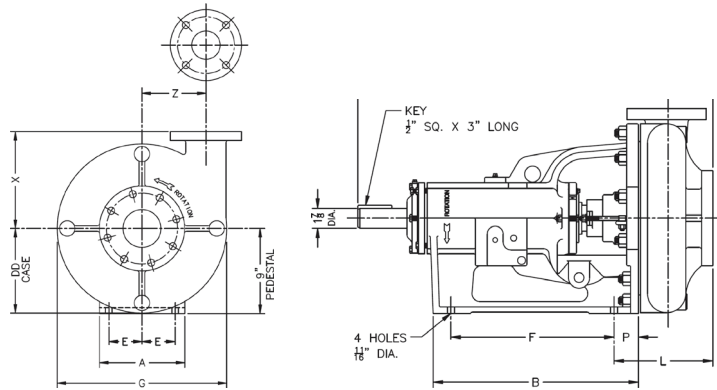

SIZE	SUCTION FLANGES		DISCHARGE FLANGES		A	B	E	F	G	L	P	X	Y	Z	CP	DD	WT
	SIZE	DRILLING	SIZE	DRILLING													
3x2x13	3	4 Holes, 3/4 D, 6 BC	2	4 Holes, 3/4 D, 4-3/4 BC	9	19-5/8	3-1/2	15-7/16	17-7/8	8-3/4	2-5/16	10-1/4	3-3/4	7	29-1/4	9	440 lbs
4x3x13	4	8 Holes, 3/4 D, 7-1/2 BC	3	4 Holes, 3/4 D, 6 BC					17-7/8	9-3/8		10-1/4	4-1/4	6-3/4	29-3/8	9	436 lbs
5x4x14	5	8 Holes, 7/8 D, 8-1/2 BC	4	8 Holes, 3/4 D, 7-1/2 BC					19	10-3/4		11	5	6-1/8	30	9-11/16	485 lbs
6x5x11	6	8 Holes, 7/8 D, 9-1/2 BC	5	8 Holes, 7/8 D, 8-1/2 BC					17-7/8	12-1/16		11	5-3/4	6	30-5/8	9	507 lbs
6x5x14	6	8 Holes, 7/8 D, 9-1/2 BC	5	8 Holes, 7/8 D, 8-1/2 BC					21	12-1/16		11	5-3/4	6	30-5/8	10-1/2	550 lbs
8x6x11	8	8 Holes, 7/8 D, 11-3/4 BC	6	8 Holes, 7/8 D, 9-1/2 BC					20	13-1/4		14	6-1/4	8-3/8	31-1/4	10	583 lbs
8x6x14	8	8 Holes, 7/8 D, 11-3/4 BC	6	8 Holes, 7/8 D, 9-1/2 BC					23-9/16	13-1/4		14	6-1/4	8-3/8	31-1/4	12	616 lbs
10x8x14	10	12 Holes, 1 D, 14-1/4 BC	8	8 Holes, 7/8 D, 11-3/4 BC					22-3/8	13-11/16		14-3/16	6-11/16	8	31-1/4	11-3/16	810 lbs

CONTROLS
ENERGY STORAGE
MOTORS
PUMPS
VALVES
COMPRESSORS
PNEUMATICS
SAWMILLS
METAL RECYCLING
TRANSIT & RAILROAD
WATER & WASTEWATER
DIMENSIONS & MOUNTING

MP-SandM Centrifugal Pumps

3x2x13 to 10x8x14 Size

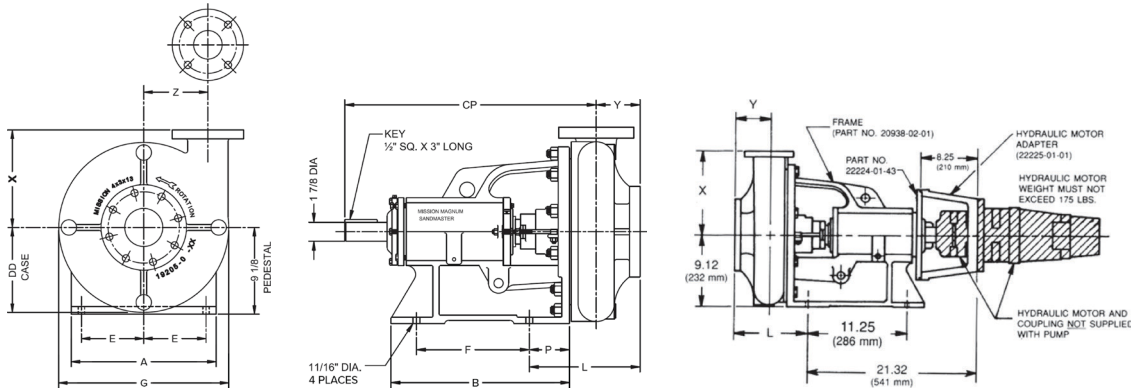

SIZE	SUCTION FLANGES		DISCHARGE FLANGES		A	B	E	F	G	L	P	X	Y	Z	CP	DD	WT
	SIZE	DRILLING	SIZE	DRILLING													
3 x 2 x 13	3	4 Holes, 3/4 D, 6 BC	2	4 Holes, 3/4 D, 4-3/4 BC	15-1/4	14-3/4	6-9/16	11-1/4	17-7/8	10-7/16	4	10-1/4	3-3/4	7	25-1/16	8-15/16	475 lbs
4 x 3 x 13	4	8 Holes, 3/4 D, 7-1/2 BC	3	4 Holes, 3/4 D, 6 BC					17-7/8	11-1/16		10-1/4	4-1/4	6-3/4	25-1/8	8-15/16	491 lbs
5 x 4 x 14	5	8 Holes, 7/8 D, 8-1/2 BC	4	8 Holes, 3/4 D, 7-1/2 BC					19	12-7/16		11	5	6-1/8	25-13/16	9-1/2	520 lbs
6 x 5 x 11	6	8 Holes, 7/8 D, 9-1/2 BC	5	8 Holes, 7/8 D, 8-1/2 BC					17-7/8	13-3/4		11	5-3/4	6	26-3/8	8-15/16	550 lbs
6 x 5 x 14	6	8 Holes, 7/8 D, 9-1/2 BC	5	8 Holes, 7/8 D, 8-1/2 BC					21	13-3/4		11	5-3/4	6	26-3/8	10-1/2	609 lbs
8 x 6 x 11	8	8 Holes, 7/8 D, 11-3/4 BC	6	8 Holes, 7/8 D, 9-1/2 BC					20	14-15/16		14	6-1/4	8-3/8	27-1/16	10	659 lbs
8 x 6 x 14	8	8 Holes, 7/8 D, 11-3/4 BC	6	8 Holes, 7/8 D, 9-1/2 BC					23-9/16	14-15/16		14	6-1/4	8-3/8	27-1/16	11-13/16	701 lbs
10 x 8 x 14	10	12 Holes, 1 D, 14-1/4 BC	8	8 Holes, 7/8 D, 11-3/4 BC					22-3/8	15-3/8		14-3/16	6-11/16	8	27-1/16	11-3/16	705 lbs

MP-LJC Vertical Pumps

100MPLJC10-4 to 350MPLJC400-18 Size

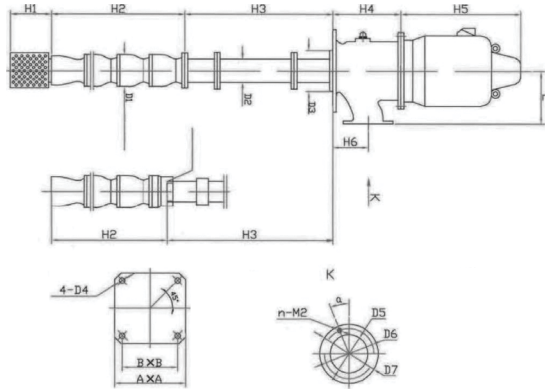

MODEL	I	A	B	D1	D2	D3	D4	D5	D6	D7	H1	H2	H3	H4	H5	H6	L	M1	M2	n	a		
100MPLJC10-4	10											1175	-					M16 x 300	M12	6	30°		
	13											1460	-										
	18	335	251.4	92	76	200	19	102	186	228	400	1935	-	343	573	127	228						
	23											2410	-										
	26											2885	-										
150MPLJC10-9	12	335	251.4	150	89	190	19	102	186	228	400	1665	-	343	573	127	228	M16 x 300	M12	6	30°		
	16	508	382			280		155	235	280		2105	-	394	807	171.5	305		M16	8	22.5°		
	20											2545	-										
150MPLJC20-11	5	335	251.4	150	89	190	19	102	186	228	400	822	-	343	573	127	228	M16 x 300	M12	6	30°		
	7											1082	-										
	9											1342	-										
	12											1732	-									394	807
150MPLJC30-12.5	6	508	382	150	114	280	19	155	235	280	400	952	-	394	807	171.5	305	M16 x 300	M16	8	22.5°		
	9											1212	-										
	10											1472	-										
	12											1732	-										
150MPLJC40-13.5	4	508	382	150	114	280	19	155	235	280	400	692	-	394	807	171.5	305	M16 x 300	M16	8	22.5°		
	6											952	-										
	8											1212	-										
	9											1342	-										
	10											1472	-									454	955
150MPLJC50-13	4	508	382	150	114	280	19	155	235	280	400	662	-	394	807	171.5	305	M16 x 300	M16	8	22.5°		
	5											792	-										
	6											922	-										
	7											1052	-										
	8											1182	-										
	9											1312	-									453.7	955
200MPLJC60-20	2	508	382	181	159	280	19	155	235	280	400	534	-	393	807	171.5	305	M16 x 300	M16	8	22.5°		
	3											696	-										
	4											858	-										
	5											1020	-										
	6											1182	-									454	955
	7											1344	-										

CONTROLS ENERGY STORAGE MOTORS PUMPS VALVES COMPRESSORS PNEUMATICS SAWMILLS METAL RECYCLING TRANSIT & RAILROAD WATER & WASTEWATER DIMENSIONS & MOUNTING

(Continued)

MODEL	I	A	B	D1	D2	D3	D4	D5	D6	D7	H1	H2	H3	H4	H5	H6	L	M1	M2	n	a		
200MPLJC80-22.5	2	508	382	181	159	280	19	155	235	280	400	534	-	394	807	171.5	305	M16 x 300	M16	8	22.5°		
	3											696	-		850								
	4											858	-	454	955								
	5											1020	-										
200MPLJC90-20	2	508	382	190.5	159	280	19	155	235	280	400	549	-	394	807	171.5	305	M16 x 300	M16	8	22.5°		
	3											714	-		850								
	4											879	-	454	955								
	5											1044	-										
200MPLJC125-18	1	508	382	190.5	159	280	19	155	235	280	400	384	-	394	807	171.5	305	M16 x 300	M16	8	22.5°		
	2											549	-		850								
	3											714	-	454	955								
	4											879	-										
250MPLJC130-8.5	4	508	382	242	194	292	19	155	235	280	470	1176	-	454	850	171.5	305	M16 x 300	M16	8	22.5°		
	6											1603	-		955								
	8					2029						-	564.5	1084	190.5							330	
	10					2456						-											
300MPLJC160-11.5	4	508	382	295	194	292	19	155	235	280	470	1293	-	454	955	171.5	305	M16 x 300	M16	8	22.5°		
	6											1781	-		955								
	8					2269						-	565	1084	190.5							330	
	10					2757						-											
300MPLJC185-12	2	508	382	295	194	292	19	155	235	280	470	805	-	454	850	171.5	305	M16 x 300	M16	8	22.5°		
	3											1049	-		955								
	5					1537						-	565	1084	190.5							330	
	6					1781						-											
300MPLJC220-13.5	2	508	382	295	194	292	19	155	235	280	470	805	-	454	850	171.5	305	M16 x 300	M20	8	15°		
	4											1293	-		955								
	5					1537						-	565	1084	190.5							330	
	6					1781						-											
350MPLJC300-15	2	560	408	346	219	405	23	257	350	395	470	851	-	470	955	245	355	M20 x 300	M20	12	15°		
	3											1143	-		1049								
	5											1727	-	470	1049							245	355
	7											2311	-										
350MPLJC370-16	1	560	408	346	219	405	23	257	350	395	470	559	-	470	955	245	355	M20 x 300	M20	12	15°		
	2											851	-		1049								
	3											1143	-	470	1049							245	355
	4											1435	-										
350MPLJC400-18	1	560	408	346	219	405	23	257	350	395	470	559	-	470	955	245	355	M20 x 300	M20	12	15°		
	2											851	-		1049								
	3											1143	-	470	1140							245	355
	4											1435	-										
350MPLJC400-18	5	560	408	346	219	405	23	257	350	395	470	1727	-	470	1140	245	355	M20 x 300	M20	12	15°		
	5											1727	-		1140								

CONTROLS

ENERGY STORAGE

MOTORS

PUMPS

VALVES

COMPRESSORS

PNEUMATICS

SAWMILLS

METAL RECYCLING

TRANSIT & RAILROAD

WATER & WASTEWATER

DIMENSIONS & MOUNTING

Rotary Feeder Assembly

12x16 to 45x55 Size

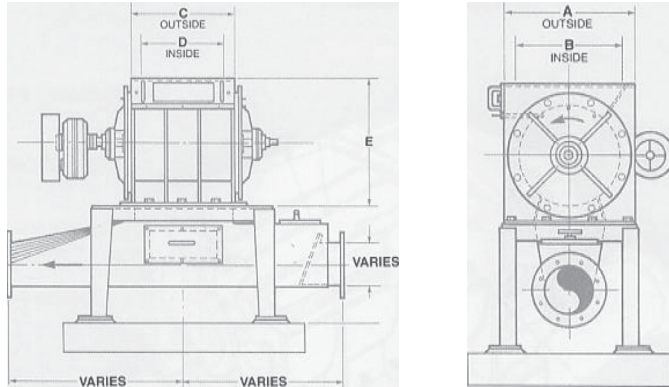

SIZE	A	B	C	D	E
12" x 16"	16"	13"	17"	13"	15"
14" x 18"	18"	15"	19"	15"	18"
16" x 20"	20"	16"	21"	17"	21"
20" x 20"	25"	21"	21.25"	17.25"	26"
20" x 25"	25"	21"	26.25"	22.25"	26"
20" x 30"	25"	21"	31.25"	27.25"	26"
25" x 30"	31"	26"	31.25"	26.25"	32"
25" x 35"	31"	26"	36.25"	31.25"	32"
30" x 30"	38"	32"	31.25"	25.25"	38"
30" x 35"	38"	32"	36.25"	30.25"	38"
30" x 40"	38"	32"	41.25"	35.25"	38"
30" x 45"	38"	32"	46.25"	40.25"	38"
35" x 45"	44"	36"	48"	42"	44"
35" x 50"	44"	36"	53"	47"	44"
35" x 55"	44"	36"	58"	52"	44"
45" x 45"	55"	43"	47"	40"	54"
45" x 50"	55"	43"	52"	45"	54"
45" x 55"	55"	43"	57"	50"	54"



(888) 384-2111 840 Gessner Rd, Ste 950, Houston, TX 77024 ISS-NA.com

© 2021 Industrial Service Solutions, LLC. All Rights Reserved. PUB2021-2